

INSTALLATION GUIDE

FREE STANDING PERGOLA

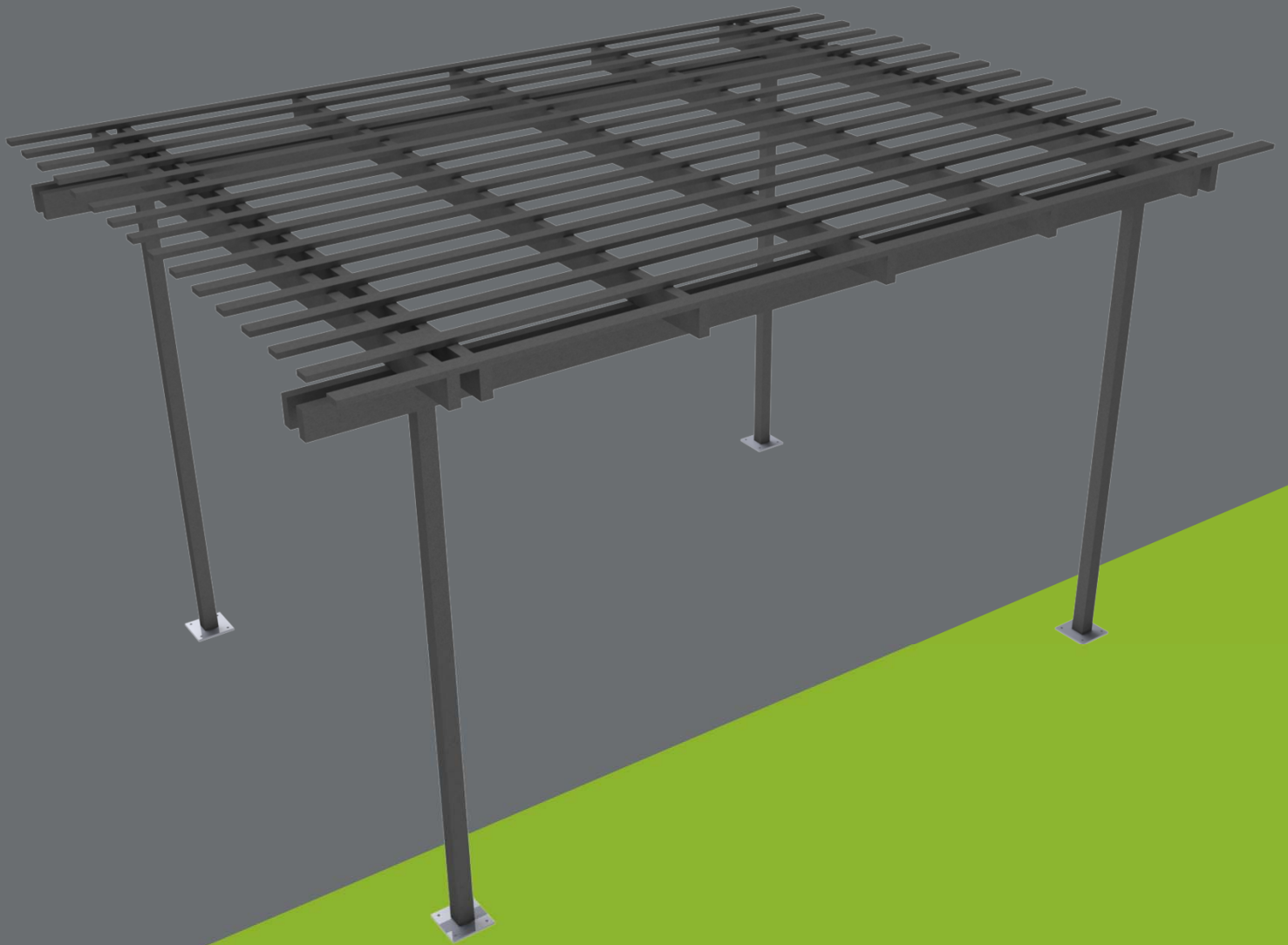

Dear Customer,

Thank you for purchasing a free standing pergola from Four Seasons Outdoor Living Solutions. This installation guide will break down the assembly method into a step by step process.

Before beginning installation, make sure you read each step carefully and that you have all the necessary tools and equipment - A list can be found on page 2. Also make sure that you have the correct quantities of components and hardware – A list can be found on pages 3, 4 & 5.

TOOLS LIST:

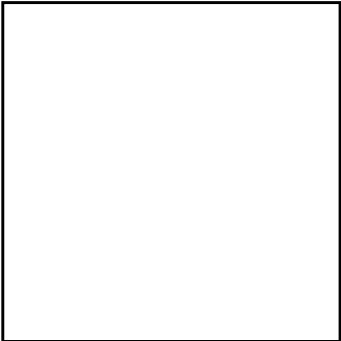

Hammer Drill

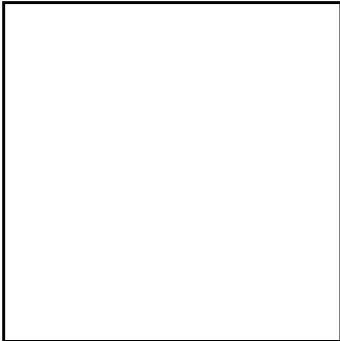

Skill Saw or Chop Saw

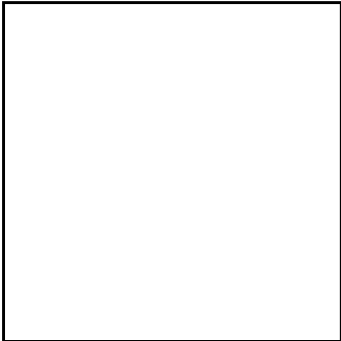

Level

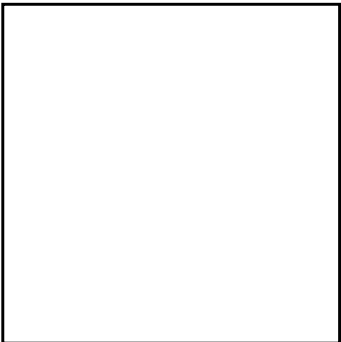

Caulking Gun

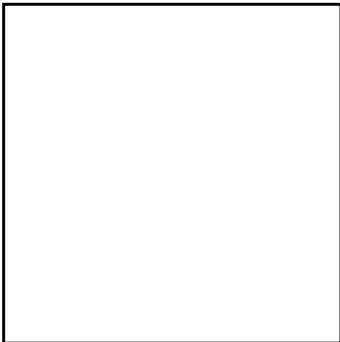

Tape Measure

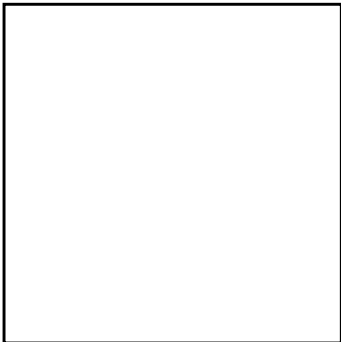

Crescent Wrench

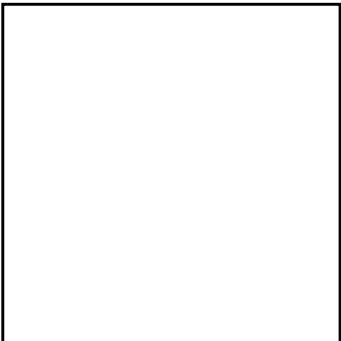

Hammer

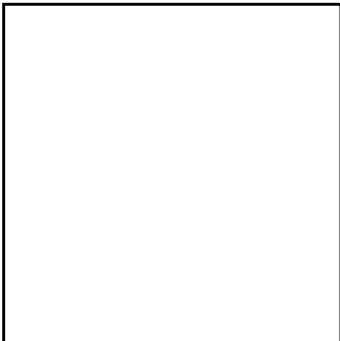

Speed Square

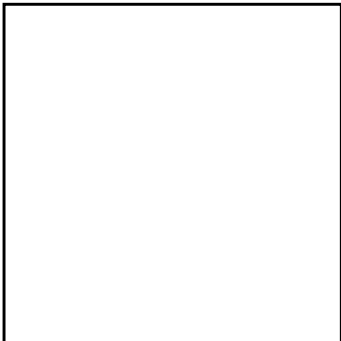

Marker Pen

12 x 12 COMPONENT CHECKLIST:

4 x
Welded Post Bases

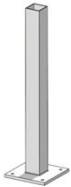

4 x 3x3
Posts

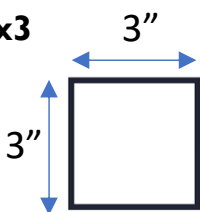

4 x 5x2
12ft Beams
w/ pre-drilled holes

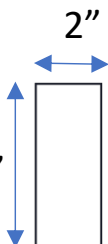

4 x 5x2
12ft Rafters
w/ pre-drilled holes



2 x 5x2
12ft Rafters
w/ out pre-drilled holes



16 x
1x3
Shade Slats

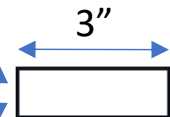

16 x
Angle Brackets



8 x Beam
End Caps



12 x
Rafter End Caps



32 x
Shade Slat End Caps



4 x Post
End Caps



16 x 1/2"
Wedge Anchors



500 x
3/4" TEK
Fastner



50 x 1" TEK
Fastner



12 x 3.5" Nut,
Bolt & Washers

16 x 12 COMPONENT CHECKLIST:

4 x
Welded Post
Bases

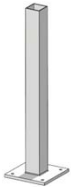

4 x 3x3
Posts

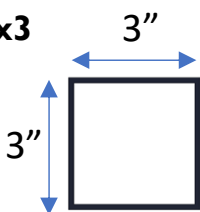

8 x 5x2 8ft
Beams
w/ pre-
drilled
holes

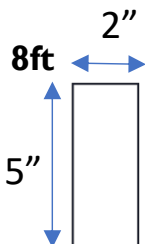

4 x 5x2
12ft Rafters
w/ pre-
drilled
holes

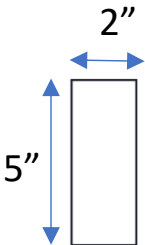

3 x 5x2
12ft Rafters
w/ out
pre-drilled
holes

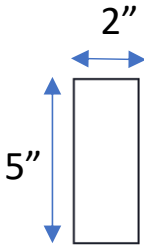

32 x
1x3
Shade
Slats

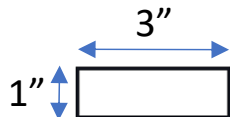

20 x
Angle
Brackets

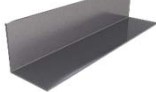

8 x Beam
End Caps



14 x
Rafter End
Caps



32 x
Shade Slat
End Caps



4 x Post
End Caps



16 x 1/2"
Wedge
Anchors



600 x
3/4" TEK
Fastner



75 x 1" TEK
Fastner



12 x 3.5" Nut,
Bolt & Washers

4 x 5x2
Beam
Splice

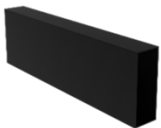

16 x 3x1
Shade Slat
Splice



20 x 10 COMPONENT CHECKLIST:

6 x
Welded Post
Bases

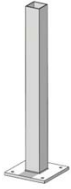

6 x 3x3
Posts

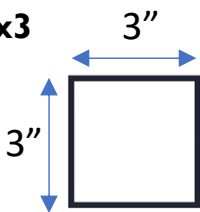

8 x 5x2
10ft Beams
w/ pre-
drilled
holes



6 x 5x2
10ft Rafters
w/ pre-
drilled
holes



4 x 5x2
10ft Rafters
w/ out
pre-drilled
holes

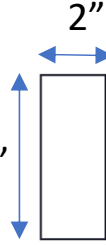

26 x
1x3
Shade
Slats

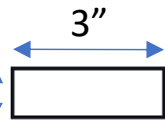

28 x
Angle
Brackets

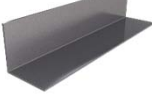

8 x Beam
End Caps



20 x
Rafter End
Caps



26 x
Shade Slat
End Caps



6 x Post
End Caps



24 x 1/2"
Wedge
Anchors



700 x
3/4" TEK
Fastner



100 x 1" TEK
Fastner



6 x 3.5" Nut,
Bolt & Washers

4 x 5x2
Beam
Splice



13 x 3x1
Shade Slat
Splice



CONCRETE FOOTINGS

1. Set out the welded corner post bases. Base plans for each size of pergola can be found on pages 7, 8 & 9. **20ft pergolas will have 6 post bases – set aside 2 for a later step.**
2. Measure diagonally from the base plates corner to corner...then measure the opposite diagonal (**Image 1**). Adjust the base plates so the diagonal measurements in both directions are equal, and match the dimensions shown on the base plan for your size of pergola.
3. Mark/Trace around the base plates to mark their location.

Image 1

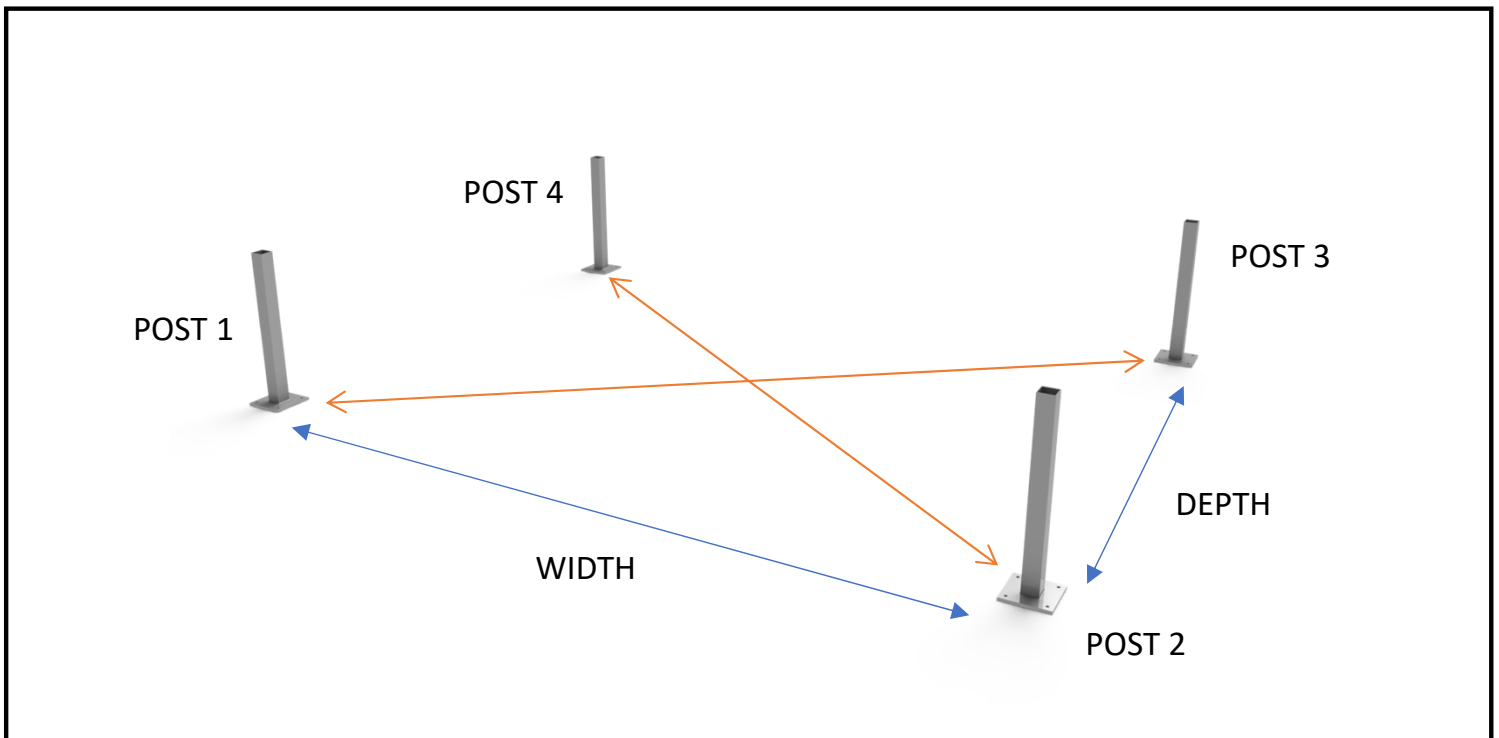

Base Plans

12 x 12 Base Plan

Part I – Setting out the post bases.

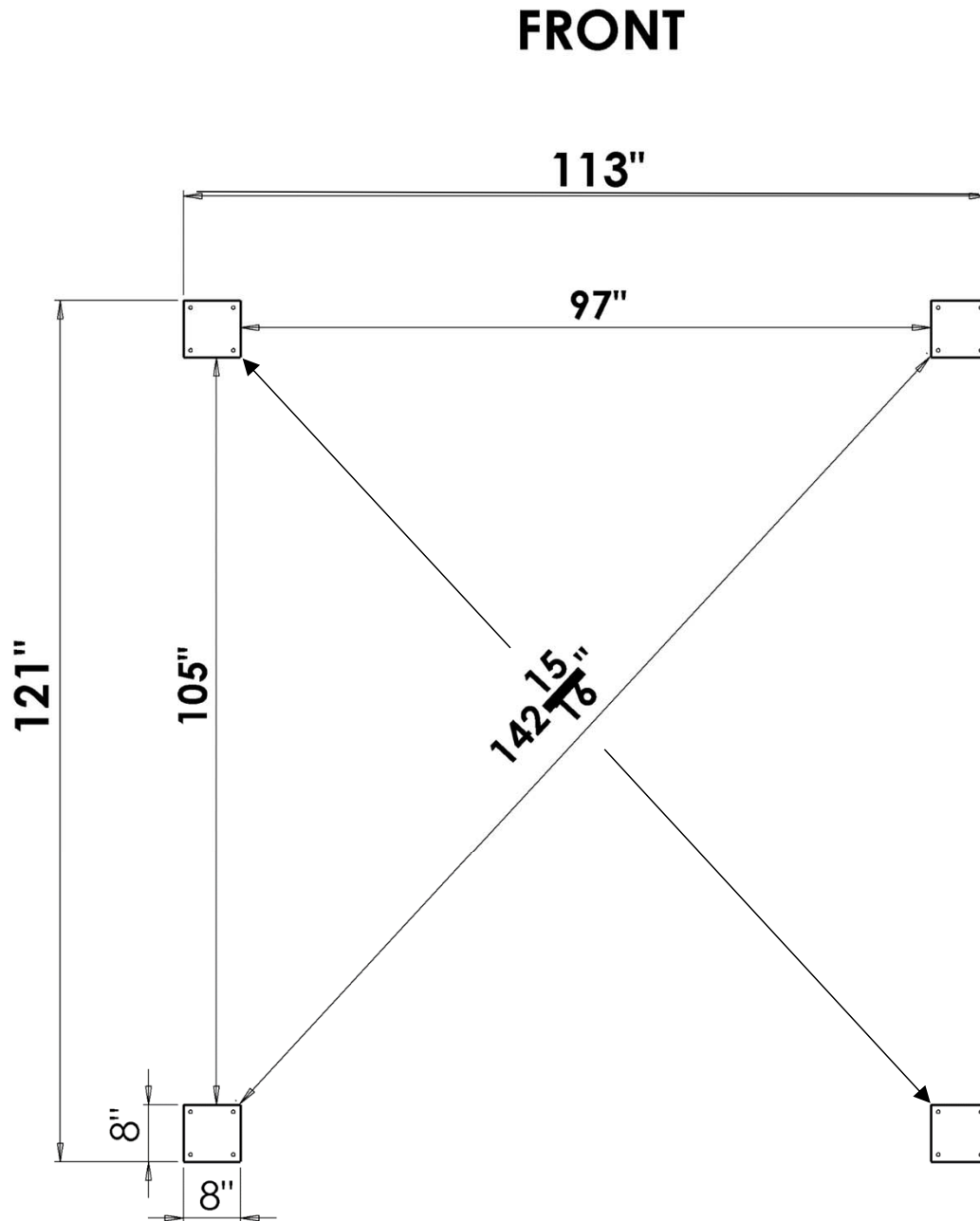

Base Plans

16 x 12 Base Plan

Part I – Setting out the post bases.

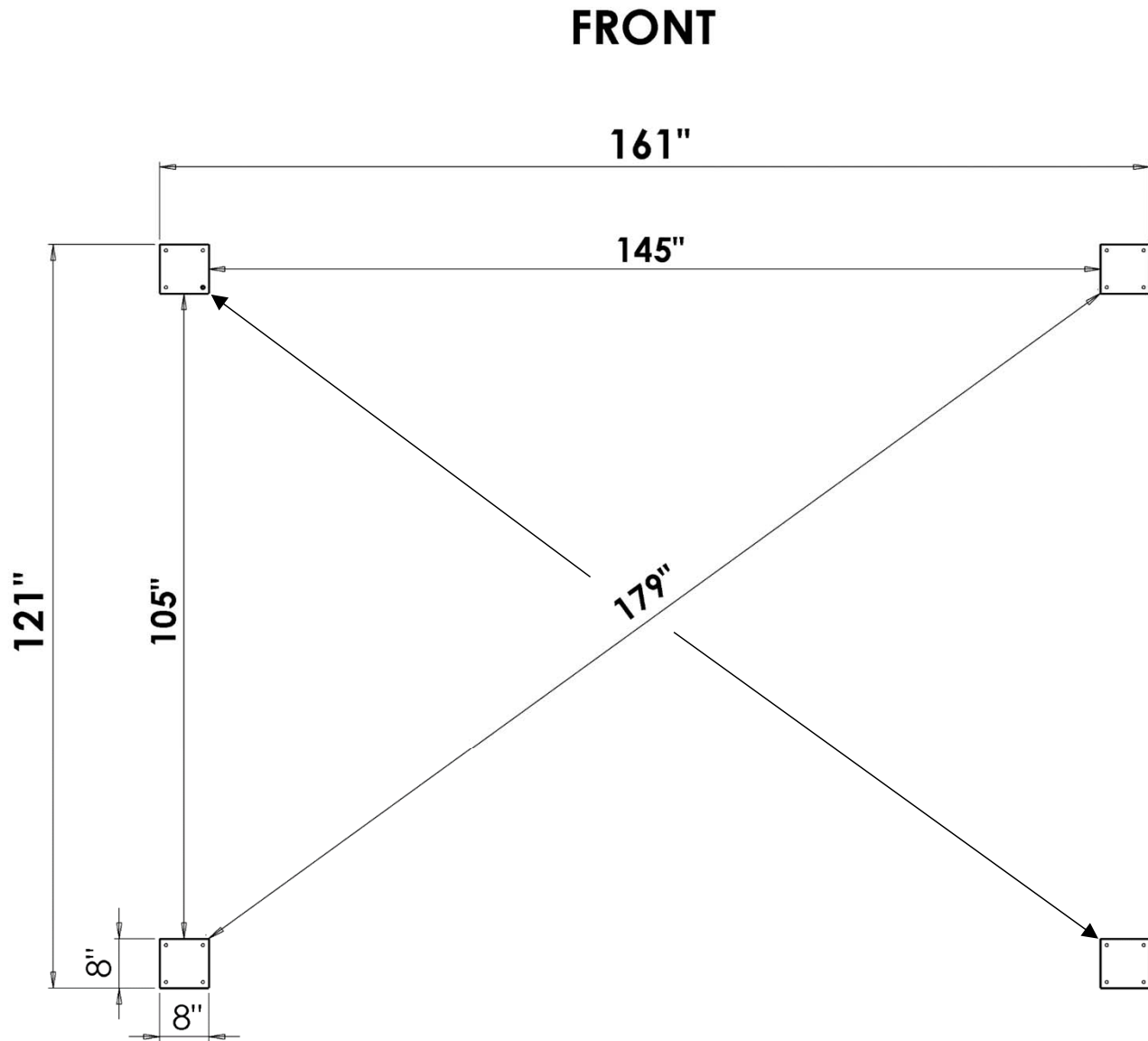

Base Plans

20 x 10 Base Plan

Part I – Setting out the post bases.

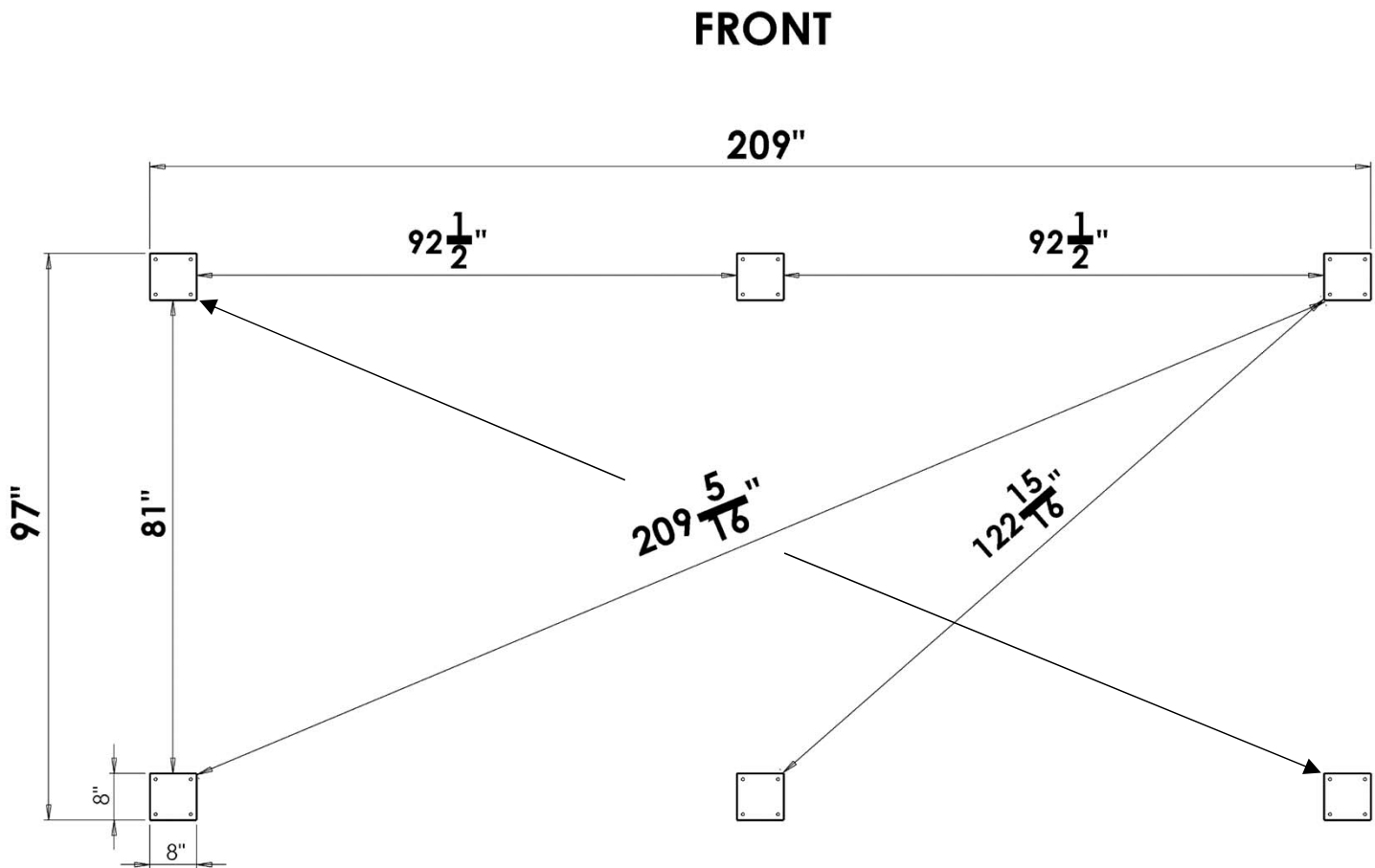

4. Dig a footing hole 25" wide x 25" across x 25" deep...(check with local building Departments for frost depth requirements & add that to your footing depth).
5. Fill with concrete and leave to set.

Note: Footings must be set before installation. The pergola must not be installed to a concrete slab alone. If installing to existing concrete slab, cut existing concrete, dig footings and fill with new concrete.

Installation

Part I: Installing End Caps (Rafters and Shade Slats)

1. Set up saw horses or a table.
2. Set all the 2"x 5" rafters on the saw horses. **Note: Take care when handling, being careful not to scratch the surface.**
3. Locate the rafter end caps.
4. Open up a tube of caulk, run a thin bead of sealant inside the 2x5 tube on the two long sides about 1/4 inch into the tube...NOT NEAR THE EDGE (**Image 3**).

Image 3

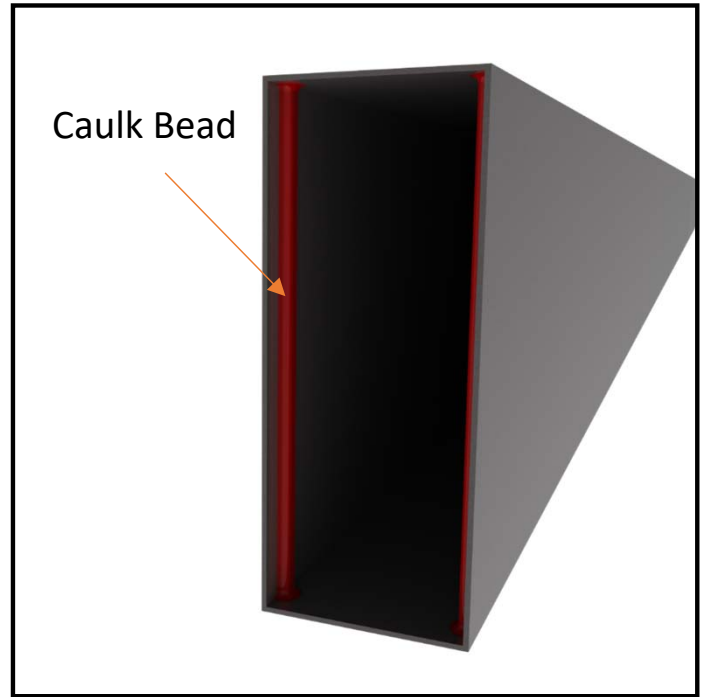
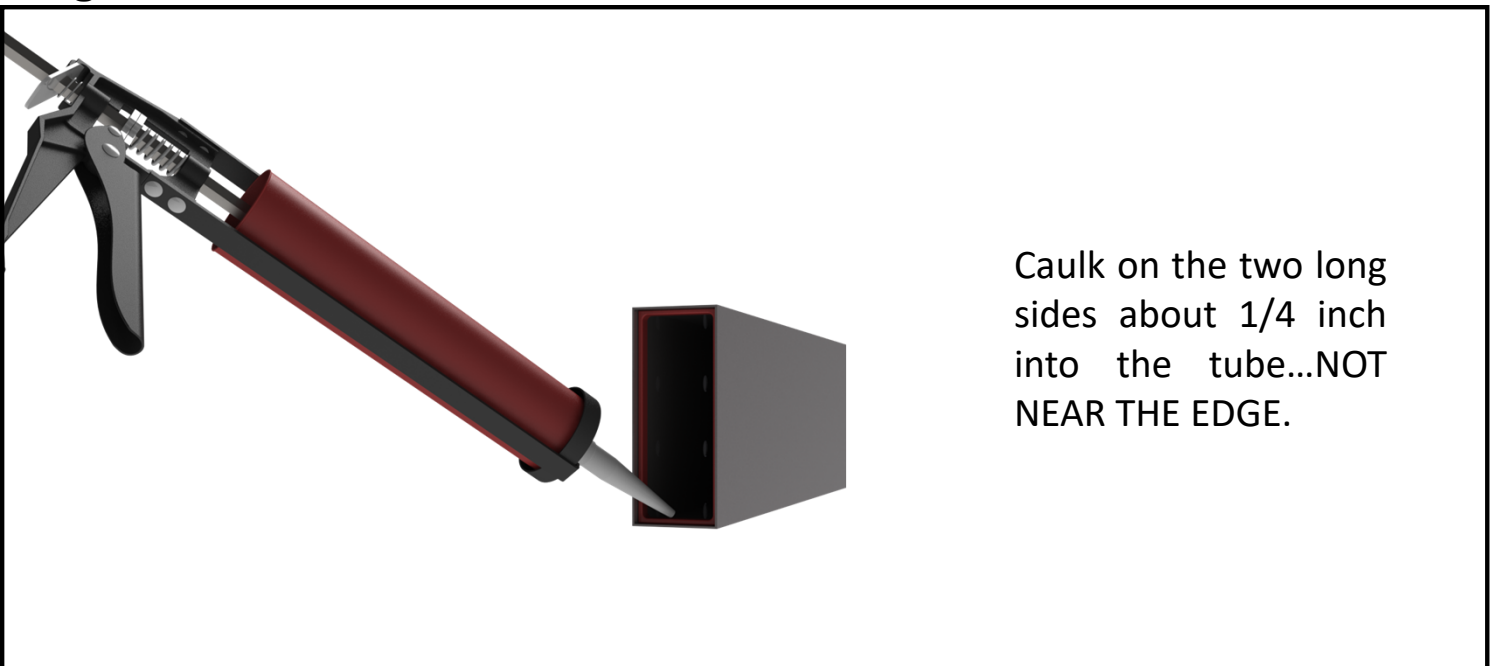

Image 2



Part I: Installing End Caps (Rafters and Shade Slats)

5. Slide in the end cap so it is flush even with the end of the 2x5 rafter (**Image 4**). Repeat for the other end of the rafter.
6. Repeat for the remaining rafters and let them set and cure for a few hours.
7. While the rafters are curing: Set out the 1x3 shade slats on the saw horses or table being careful not to scratch them.

Image 4

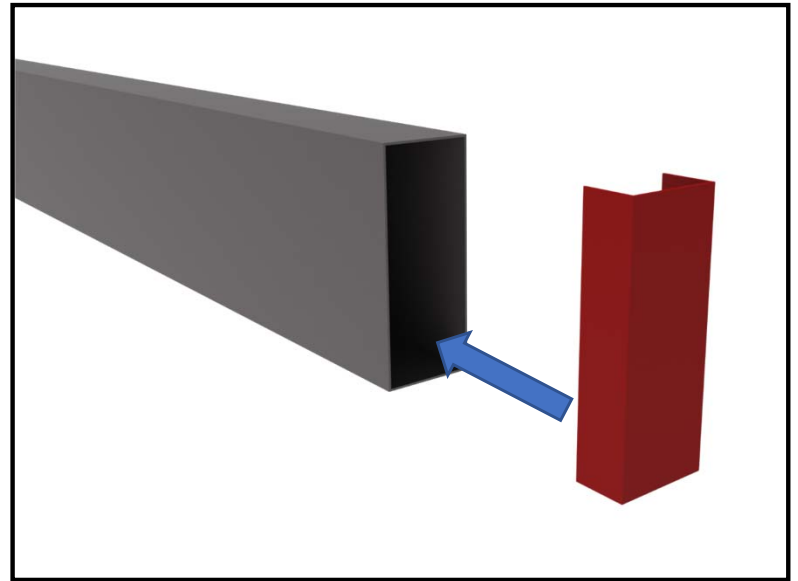

8. Locate the plastic shade slat end caps.

For 12ft wide pergolas: insert end caps into BOTH ends of the shade slats. (32 End Caps)

For 12x16ft wide pergolas: insert end caps into ONE end of the 8ft shade slats. (32 End Caps)

For 10x20ft wide pergolas: insert the end caps into ONE end of the 10ft shade slats. (26 End Caps)

Part I: Installing End Caps (Rafters and Shade Slats)

9. Insert the end caps into the appropriate shade slats (see previous step for guidance). Tap the end caps into place using a hammer. **(Image 5) (Image 6).**

Image 5

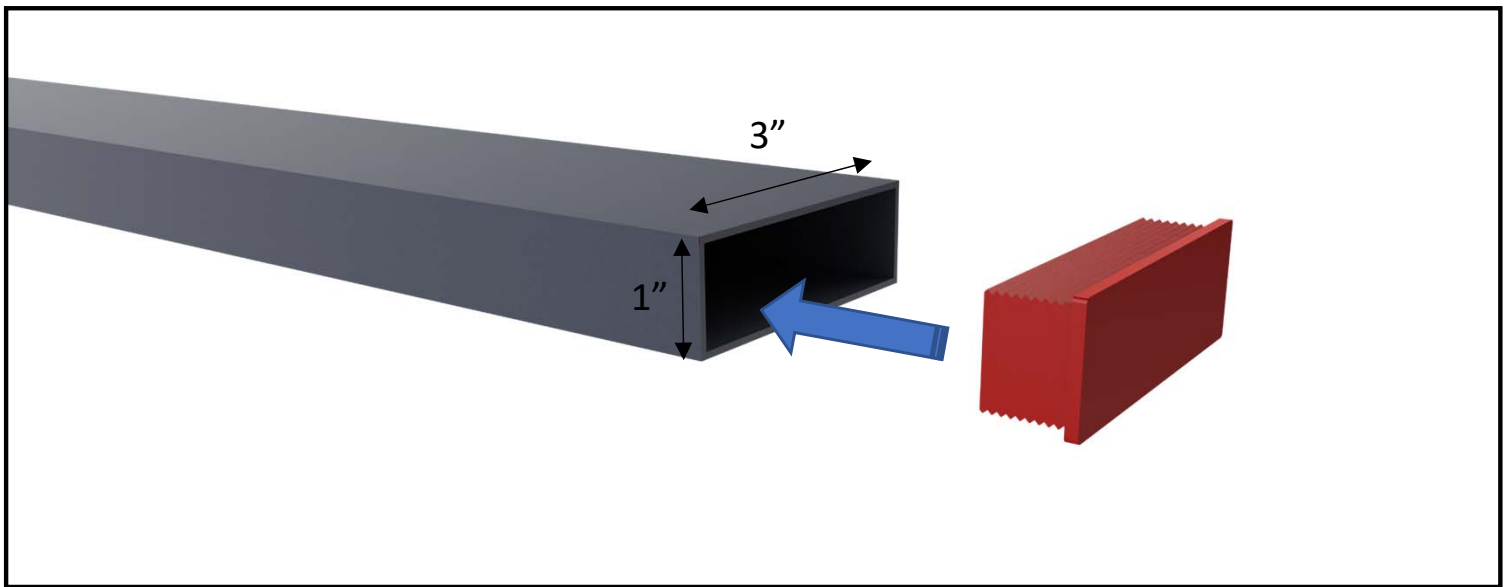
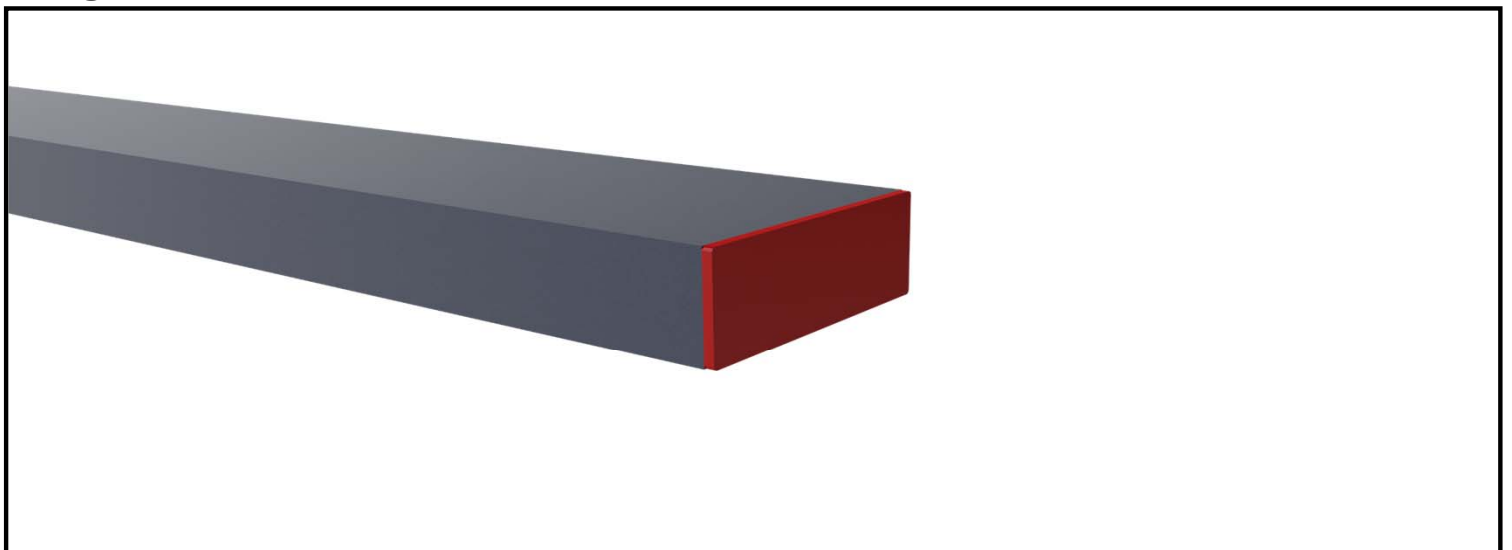

Image 6



16ft and 20ft Pergolas Only – Skip to Part 2 if not applicable

11. 16 ft pergolas: IN the OPEN END of 16 shade slats....insert the silver 3" splice for 1x3 slats half way into the slat and fasten with one (1) #10x3/4 tek on the 3" top side (**Image 7**).

12. 20 ft pergolas: IN the OPEN END of 13 slats....insert the silver 3" splice for 1x3 slats half way into the slat and fasten with one (1) #10x3/4 tek on the 3" top side (**Image 7**).

Image 7

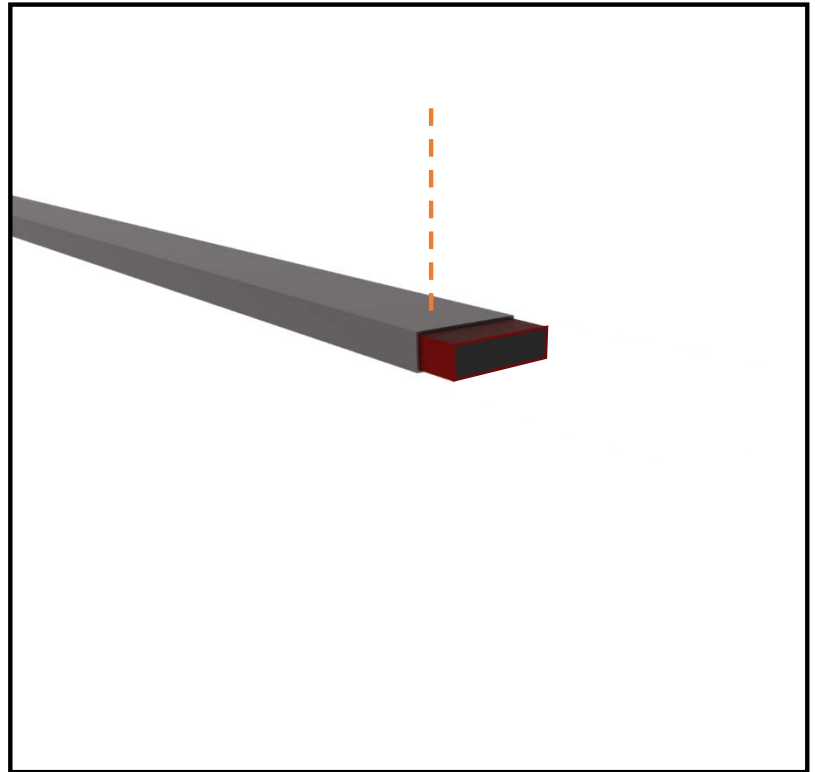

16 ft pergolas: For 16ft wide Pergolas you will have 8 pieces of 8ft 2"x5" beams with each beam having 2 holes pre-drilled at one end. There will also be 4 silver colored splices to join the beams together to make 4 beams 16ft long.

20 ft pergolas: For 20ft wide Pergolas you will have 8 pieces of 10ft 2"x5" beams with each beam having 2 holes pre-drilled at one end. There will also be 4 silver colored splices to join the beams together to make 4 beams 20ft long.

16ft and 20ft Pergolas Only – Skip to Part 2 if not applicable

13. Set 2 pieces of a 2" x 5" beam on a flat smooth surface taking care not to scratch the profile. Have the pre-drilled holes at opposite ends.
14. Measure and mark the silver 16" long SPLICE at 8" (**Image 8**).

Image 8

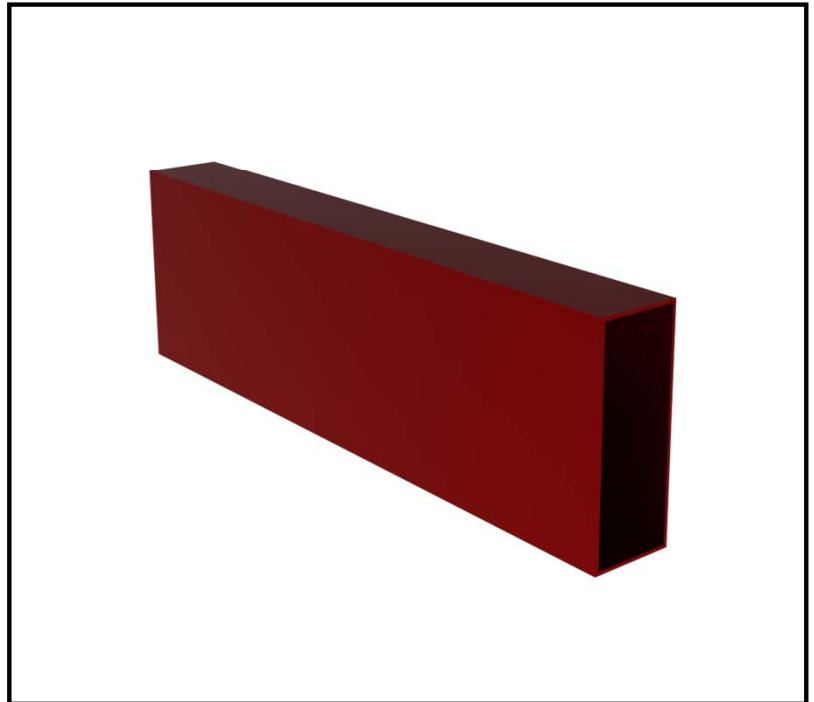

Image 9



16ft and 20ft Pergolas Only – Skip to Part 2 if not applicable

16. Slide the 16" SPICE into one of the beams to the center 8" mark of the splice. Using the #14 tek screws, Fasten through the beam into the splice on the screw pattern marks.
17. Slide the second beam over the splice and BUTT the TWO BEAMS for a TIGHT fit. Make sure both beams are STRAIGHT and the JOINT is TIGHT.

Image 10

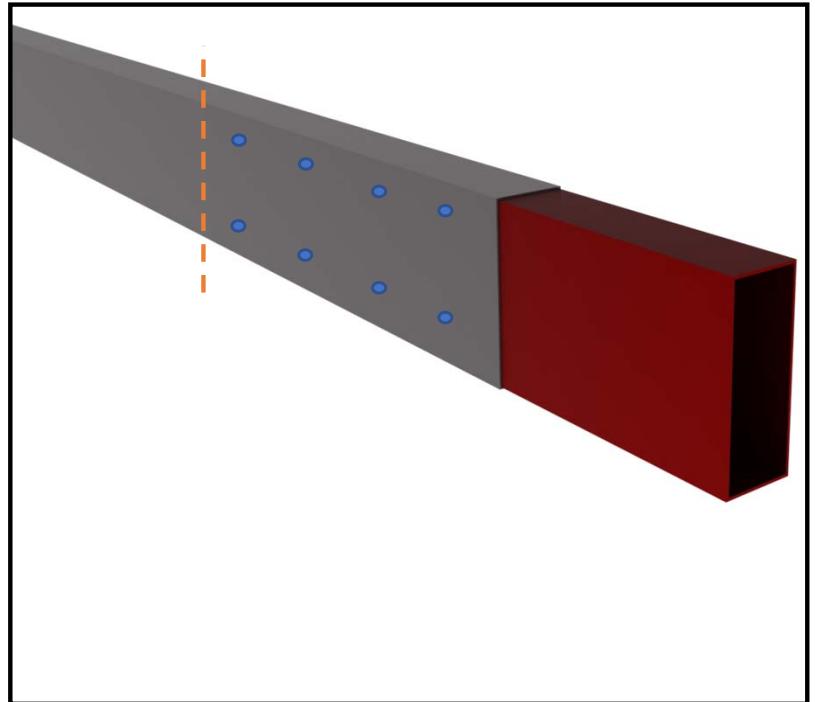

18. Using the #14 tek screws, Fasten through the beam into the splice on the screw pattern marks. Fasten up through the bottom of the beams into the splice as shown in the fastening pattern (**Image 10**).
19. Turn the beam over and fasten the second side following the screw pattern.
20. Repeat & complete for the other 3 sets of beams

Part 2: Anchoring the Post Bases to Footings

Note: Make sure to let all new footings cure for 24hrs prior to installing the post bases.

1. Set the Welded base plates on the footings.
2. Repeat steps 1 & 2 in **Part I** of this guide to position the post bases.
3. Set 2 2"x5" beams with the pre-drilled 5/8" holes across from Base #1 & #2 and #3 & #4 to center the holes with the post stubs as a check for the measurements (**Image 11**).

Image 11

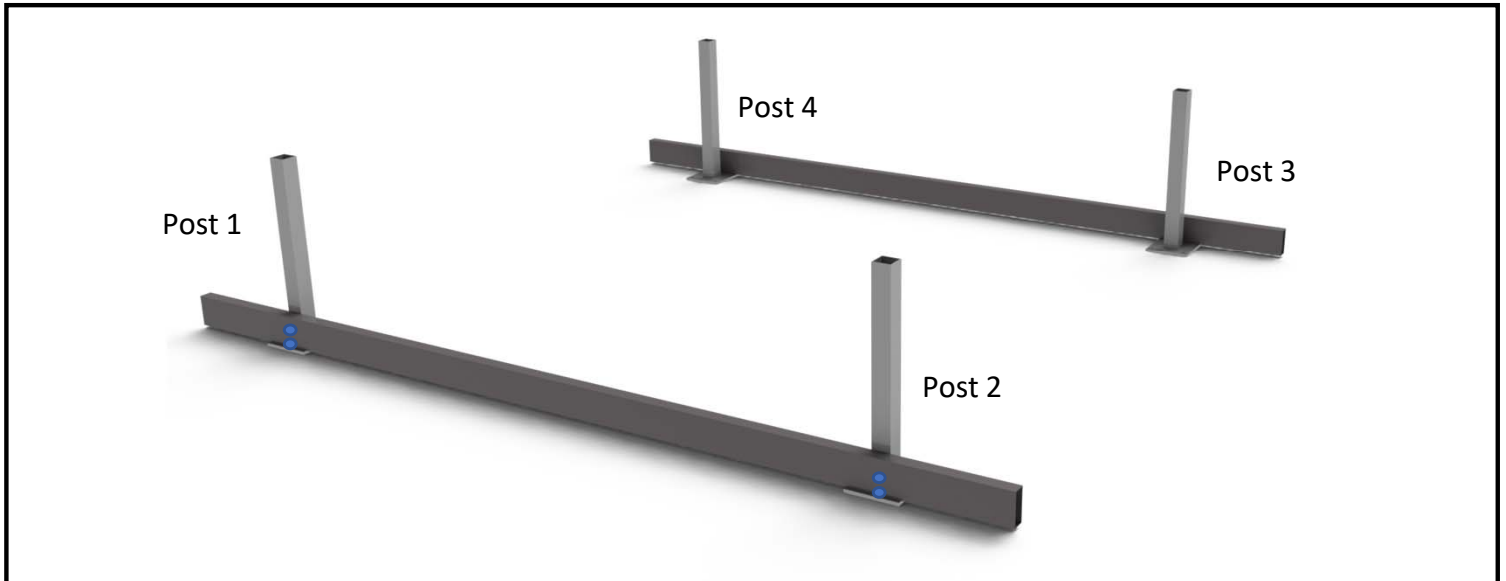

4. Use the 2 rafters with pre-drilled holes to check the distance between bases #1 & #4 and #2 & #3.

Image 12

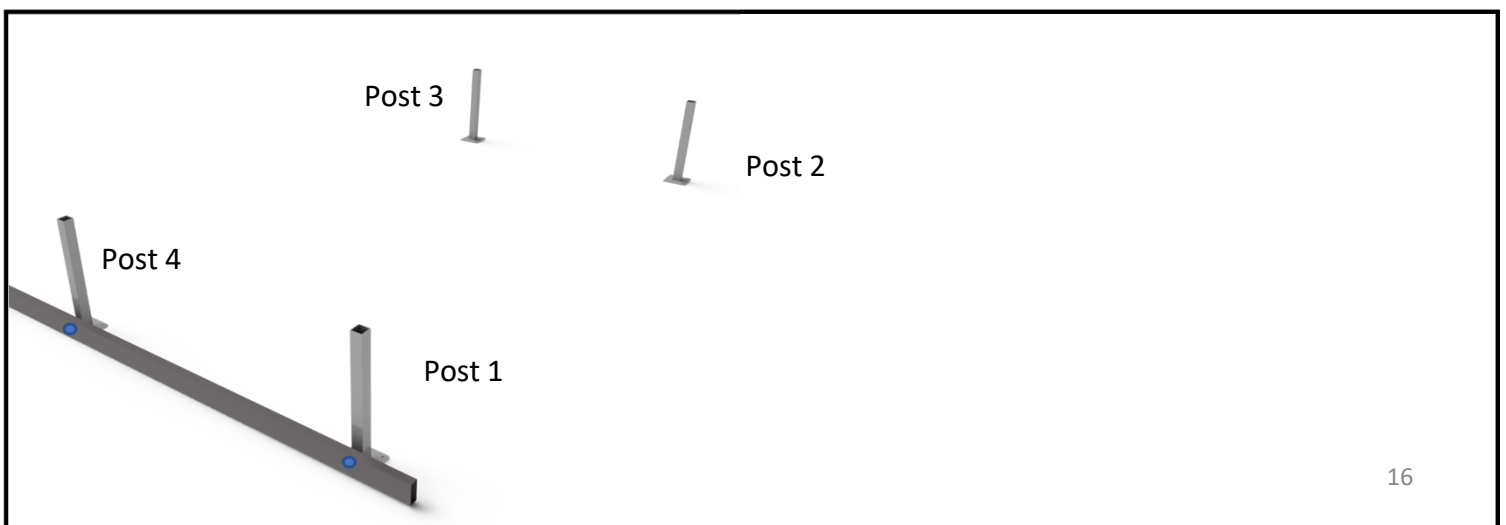

Base Plans

12 x 12 Base Plan

Anchoring the Post Bases to Footings

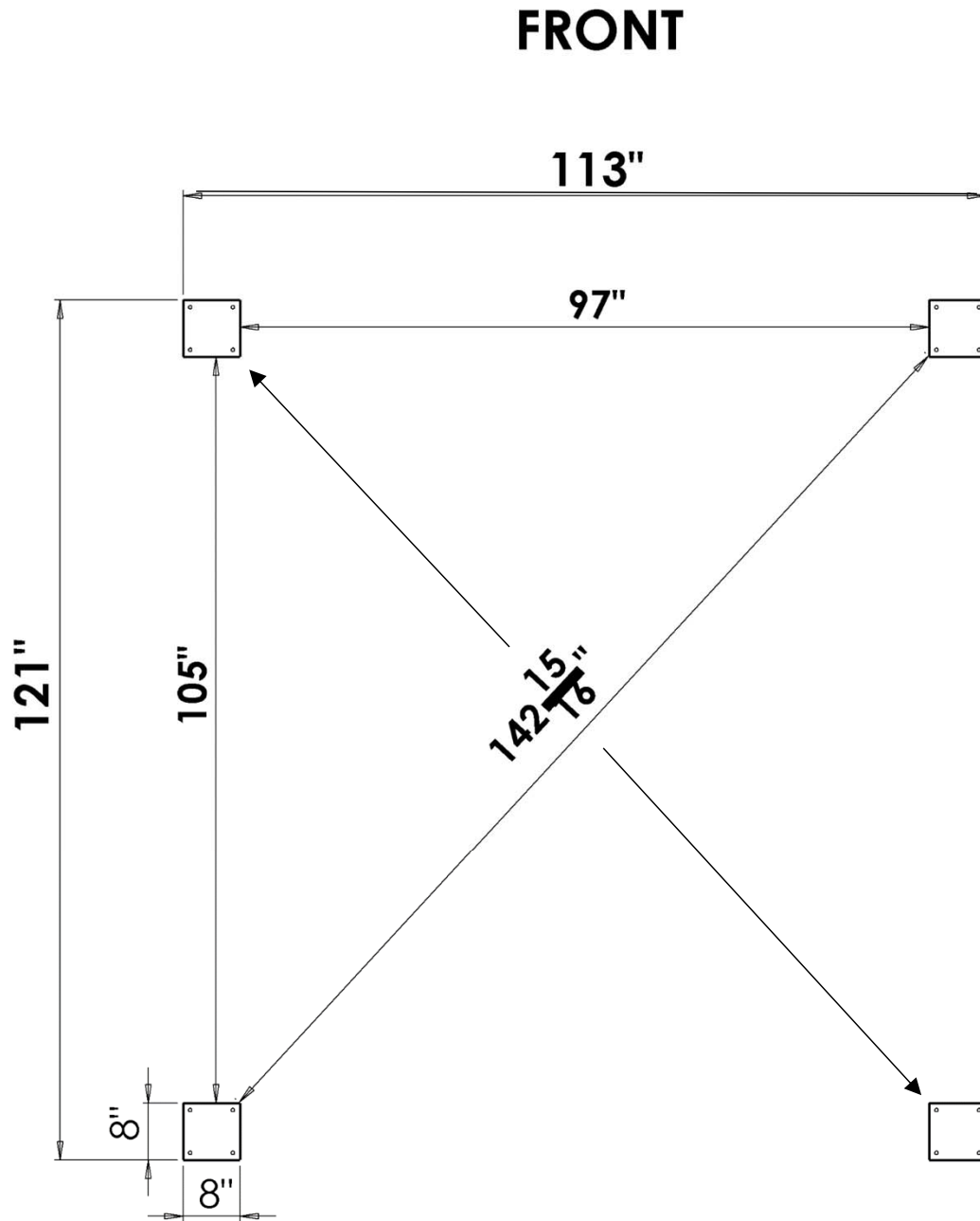

Base Plans

16 x 12 Base Plan

Anchoring the Post Bases to Footings

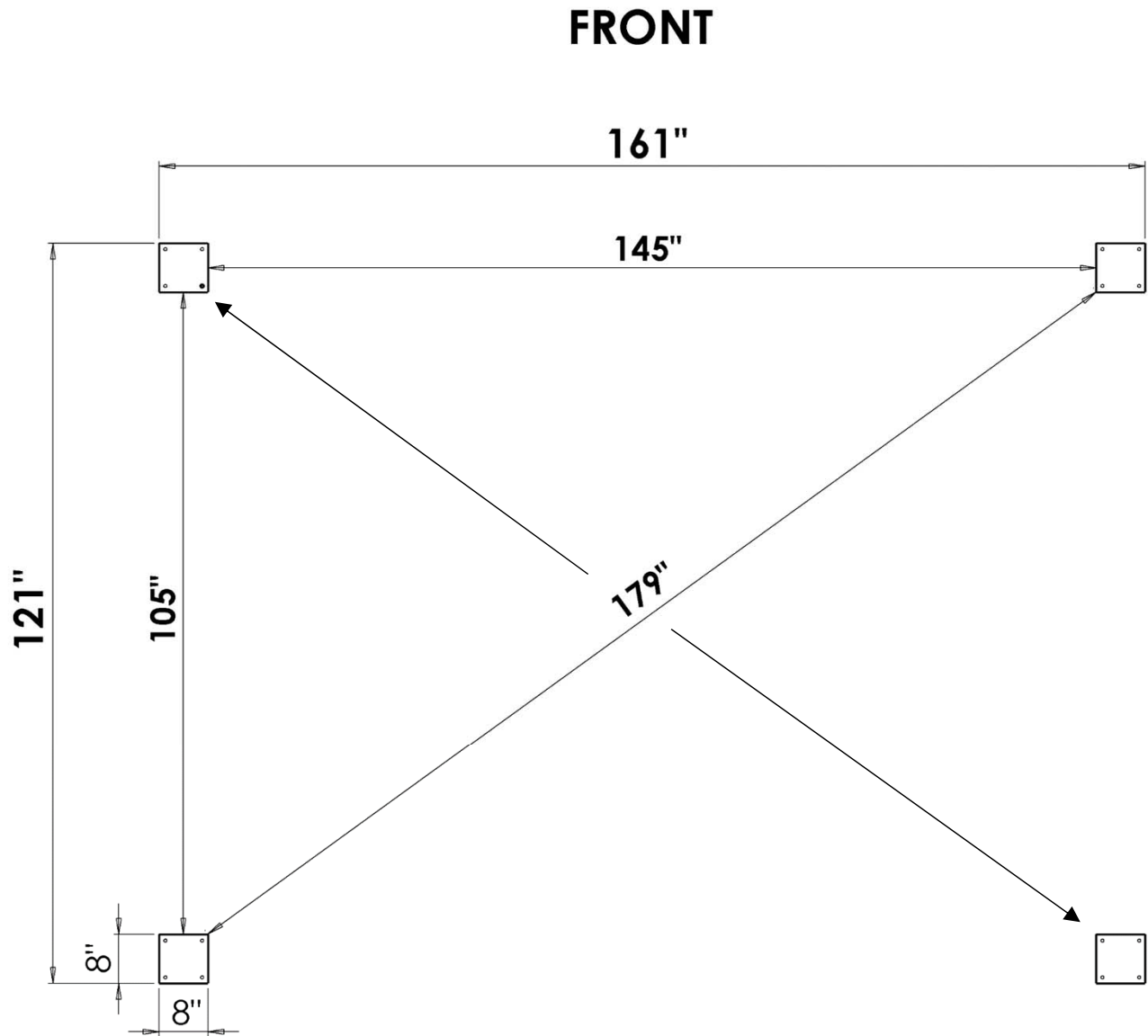

Base Plans

20 x 10 Base Plan

Anchoring the Post Bases to Footings

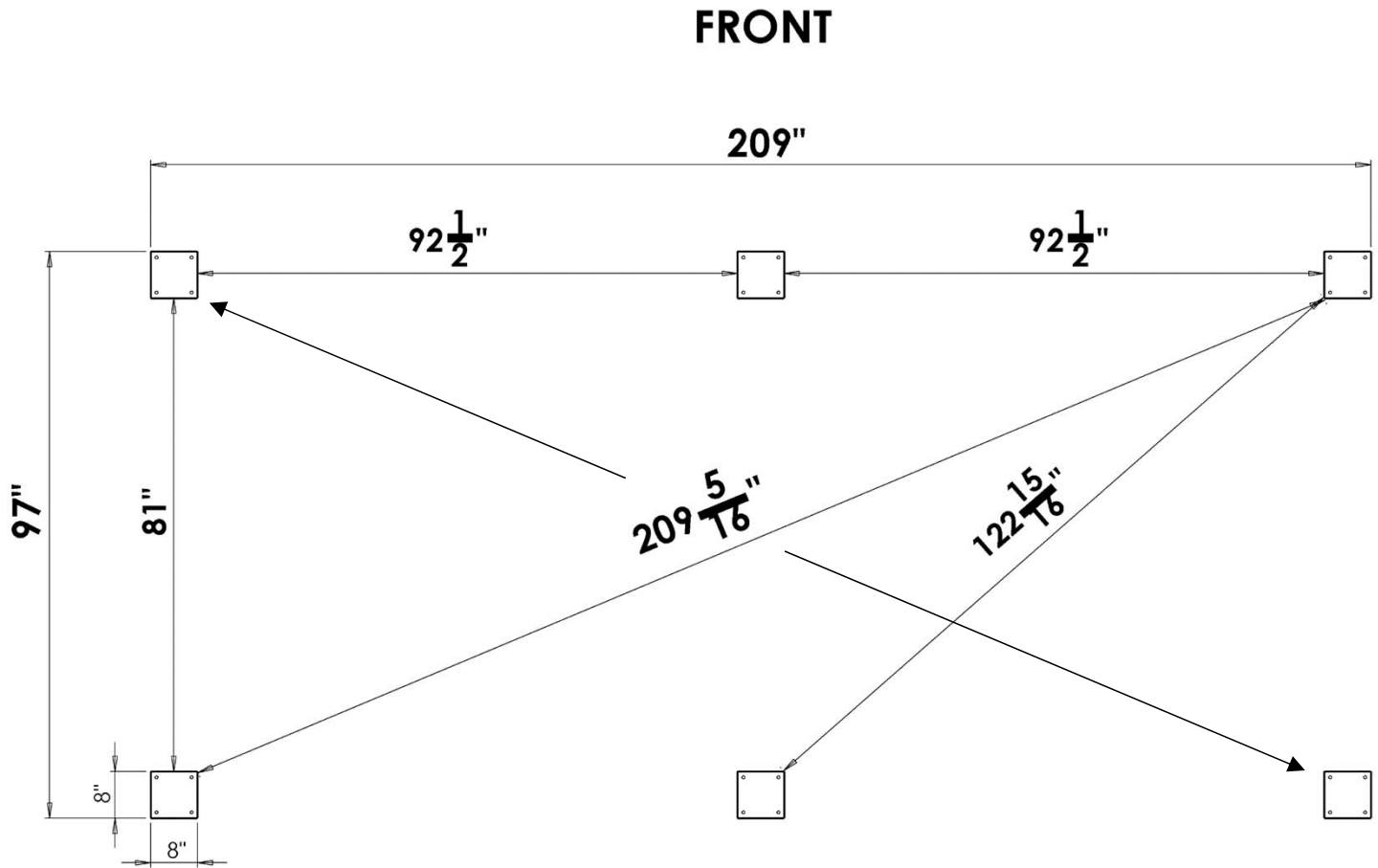

Part 2: Anchoring the Post Bases to Footings

4. Start with base #1, DRILL one 1/2" hole, at least 4" deep, using a masonry bit & Hammer drill thru the base plate hole.
5. Tap in the Wedge Anchor into the hole, spin the nut down a little and hit the bolt head with hammer into the hole & tighten the nut snug (**Image 13**).
6. Drill a second hole diagonally across from the first hole and repeat steps 4&5.
7. Finish the remaining holes and anchors in base #1.
8. With #3 base on its footing. Check the diagonal measurement is correct and repeat steps 4,5,6&7 for base #3 (**Image 14**).
9. Repeat steps and measurements for bases #2 & #4

Image 13

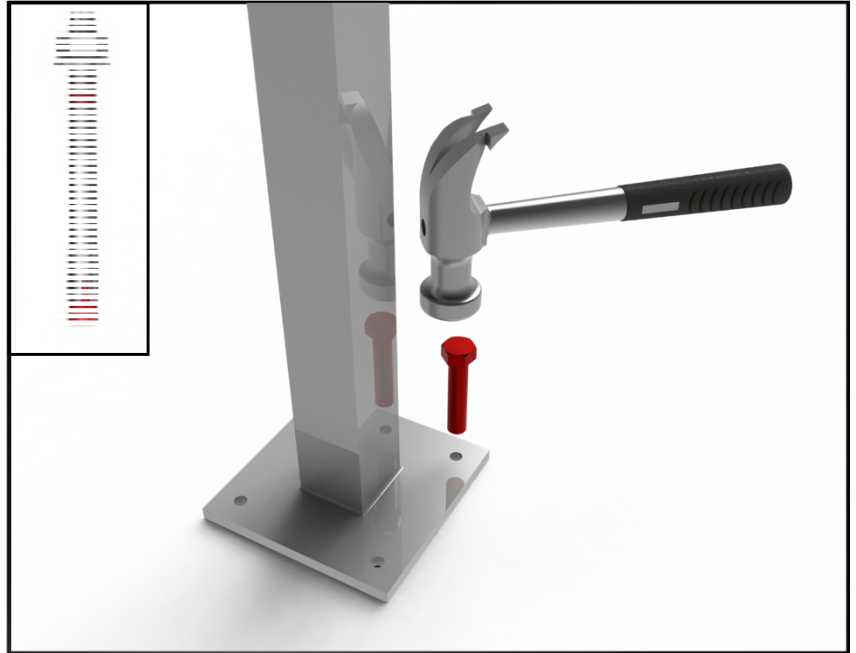
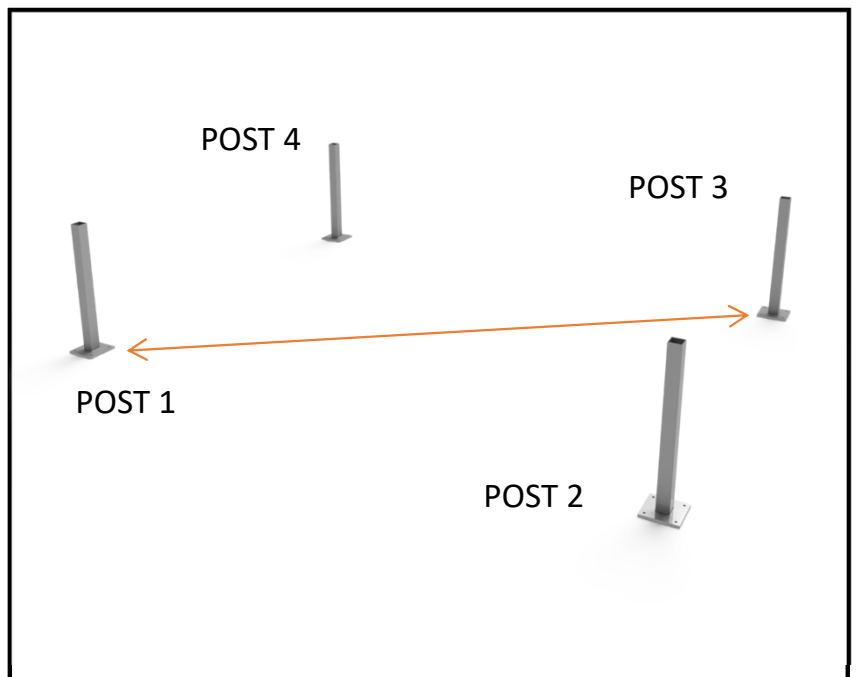

Image 14



Part 3: Installing the Posts & Beams

1. Set a 2"x5" rafter on the footings of #1 & #4. Place a level on the beam to see which footing (post 4 or post 1) is lower. **(Image 15)**.

Image 15

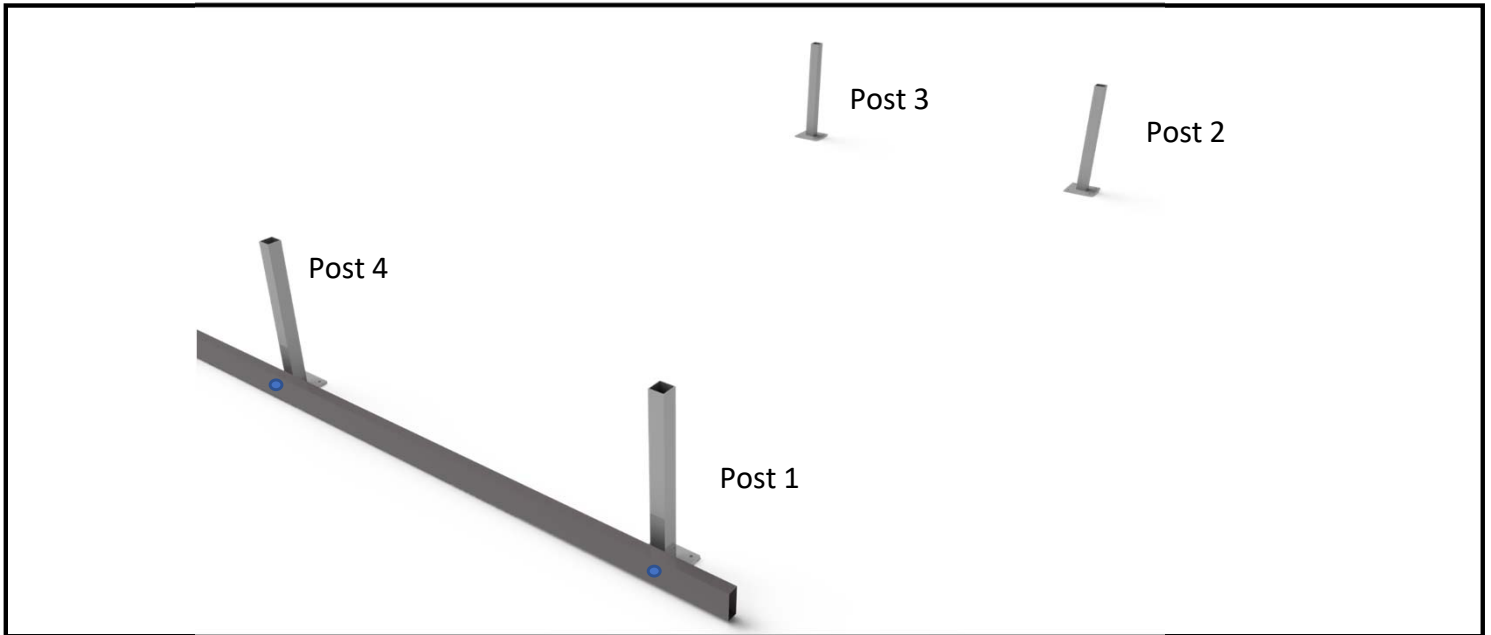

2. Repeat step 1 with footings #2 & #3. Note which is lower.
3. Now run a beam connecting the two lowest footings. Level it to find the lowest footing out of all 4. (This could be a diagonal e.g post 3 to post 1) **(Image 16)**.

Image 16

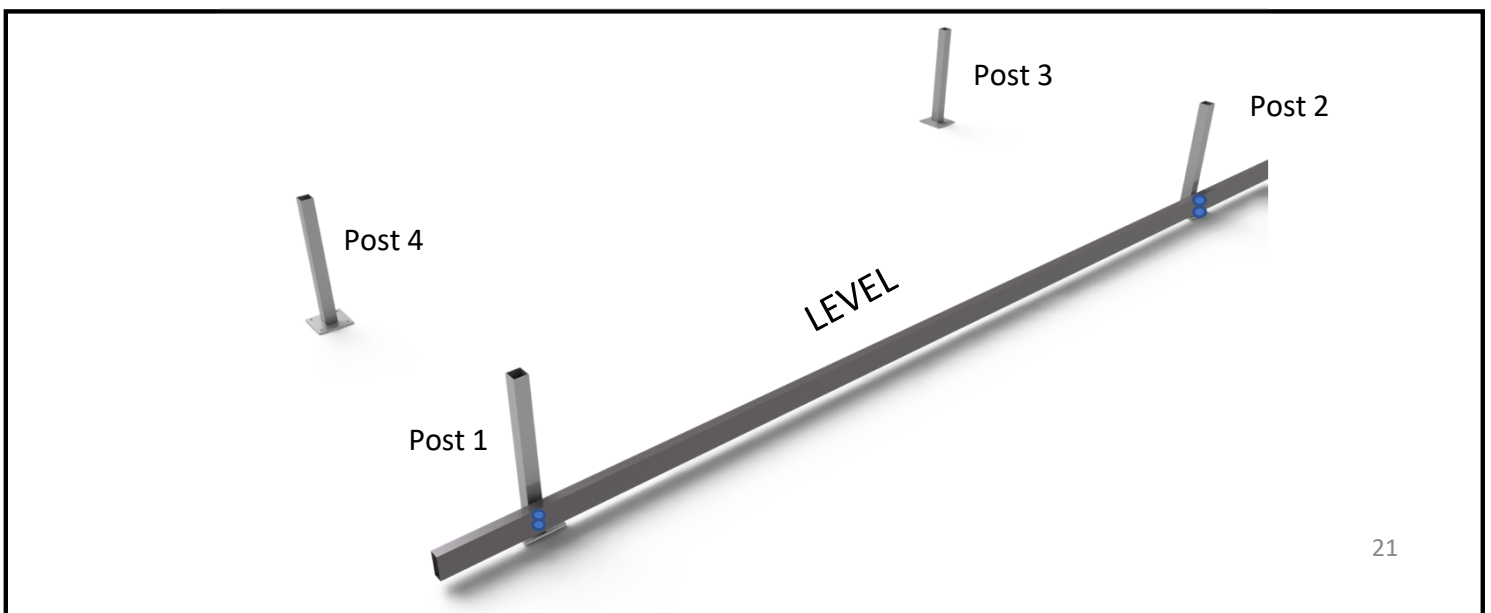

Part 3: Installing the Posts & Beams

Bases #1 & #2 are paired together for the double beams. Bases #3 & #4 are paired together for the double beams.

4. Measure down 4-3/4" from the top of a 9ft post and mark it. Set one of the 9ft long 3"x3" posts over the LOWEST base. (In the example images this is base #2) Set another 9ft long 3"x3" post over the paired mate to the LOWEST base.
5. Set a ladder by each post. 2 people lift up the 2"x5" beam, which has two holes 5/8" diameter drilled near each end. The holes should line up in the center of each post. The person at the LOWEST FOOTING holds the top of beam even with the top of the post. The second person levels the beam and MARKS the **second** post on the top side of the beam (**Image 17**).

Image 17

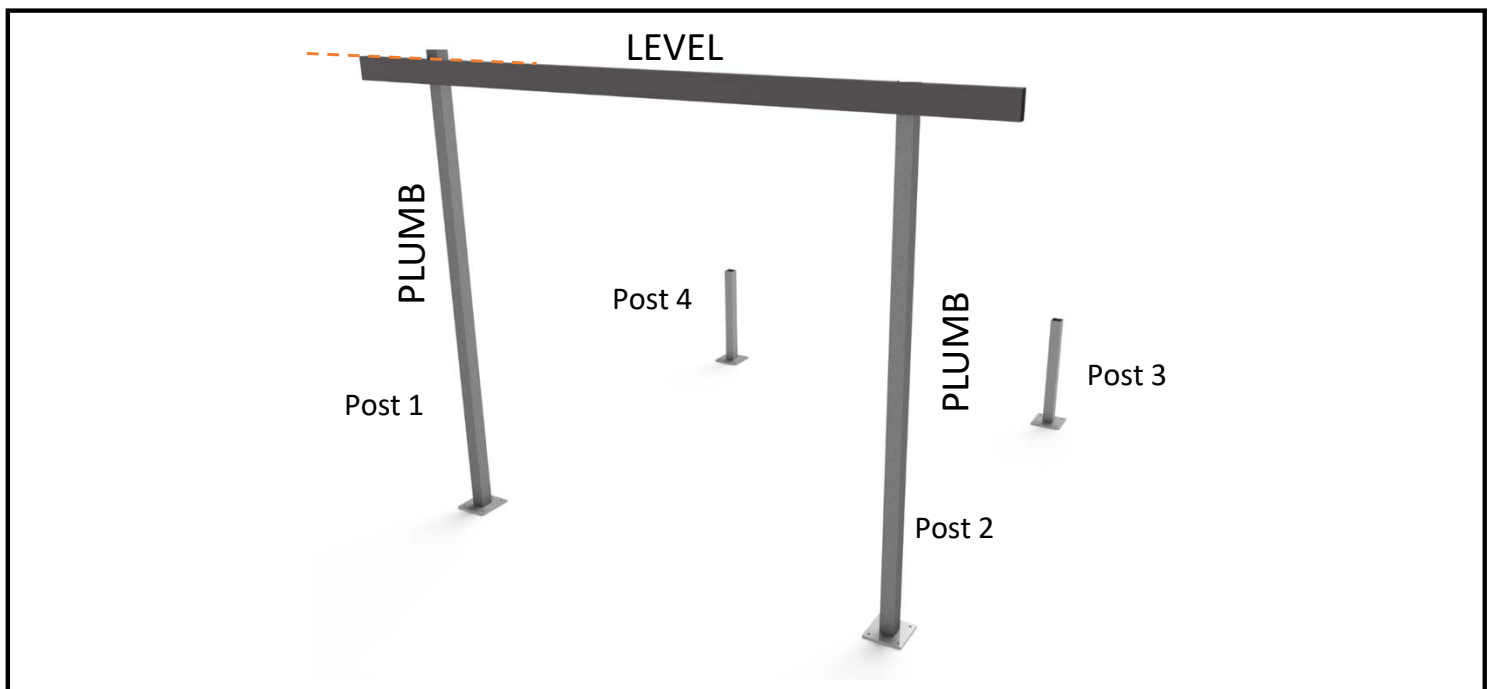

6. Cut the post at the mark made using a chop saw, skill saw or hacksaw.

Part 3: Installing the Posts & Beams

7. Measure down 4-3/4" from the TOP of the **SECOND POST** and mark it. Hold the posts plumb level vertically, center the BEAM 5/8" access holes to the posts. Hold the top of beam UNDER the 4-3/4" mark on BOTH POSTS... RE-CHECK beam to be LEVEL (**Image 18**).

Image 18

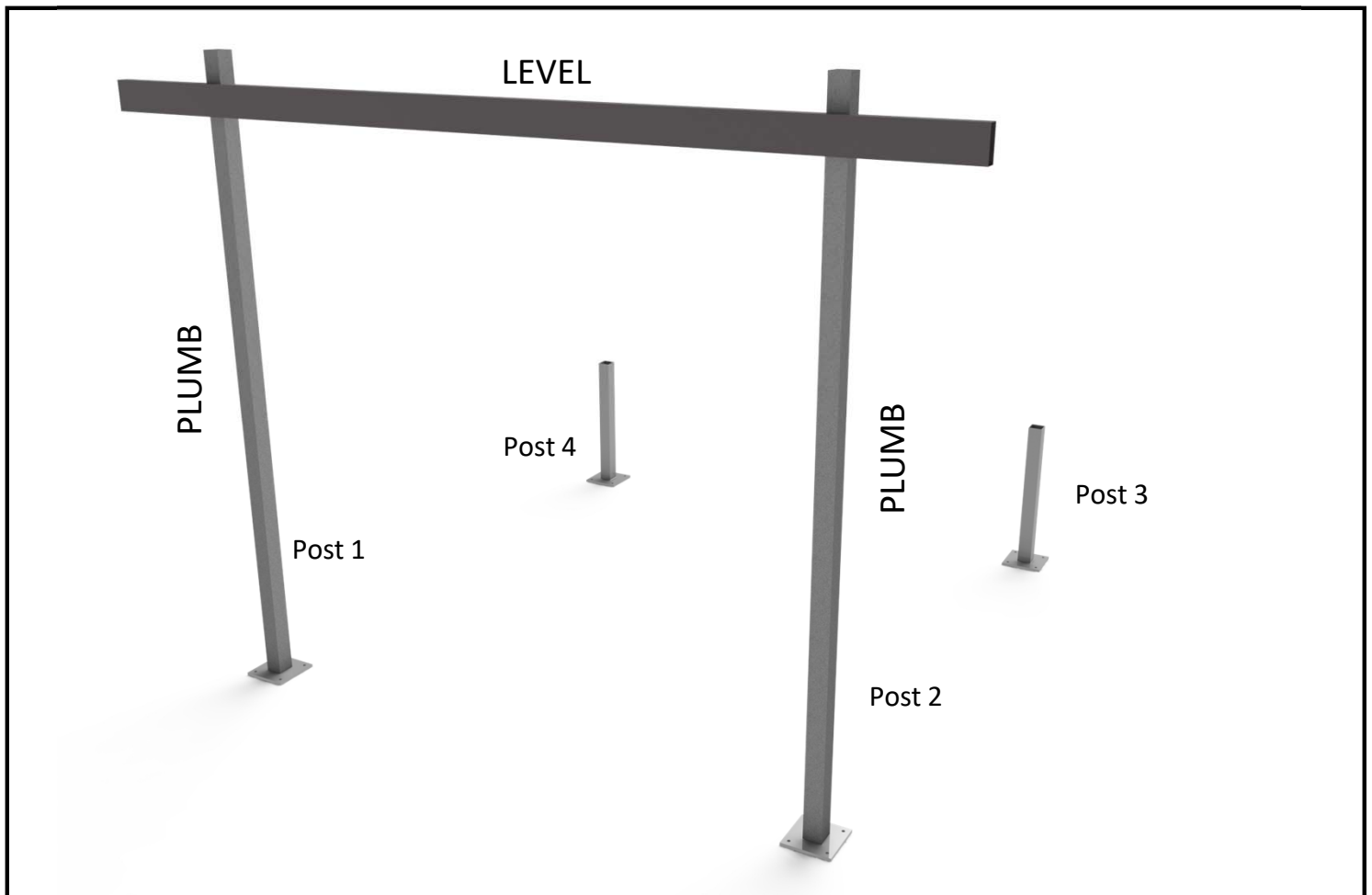

8. FASTEN through the access holes into the post using the #14 tek screw.
9. After the first beam is up, set the posts on the remaining 2 post bases with ladders beside them.

Part 3: Installing the Posts & Beams

10. Take a 2"x5" **rafter with pre drilled holes**, set it on the beam, level it across to the opposite post. Make sure both are plumb level vertically. The holes in the rafter should line up with the center of the posts. Mark a line above the rafter on the second post. **(Image 19)**.

Image 19

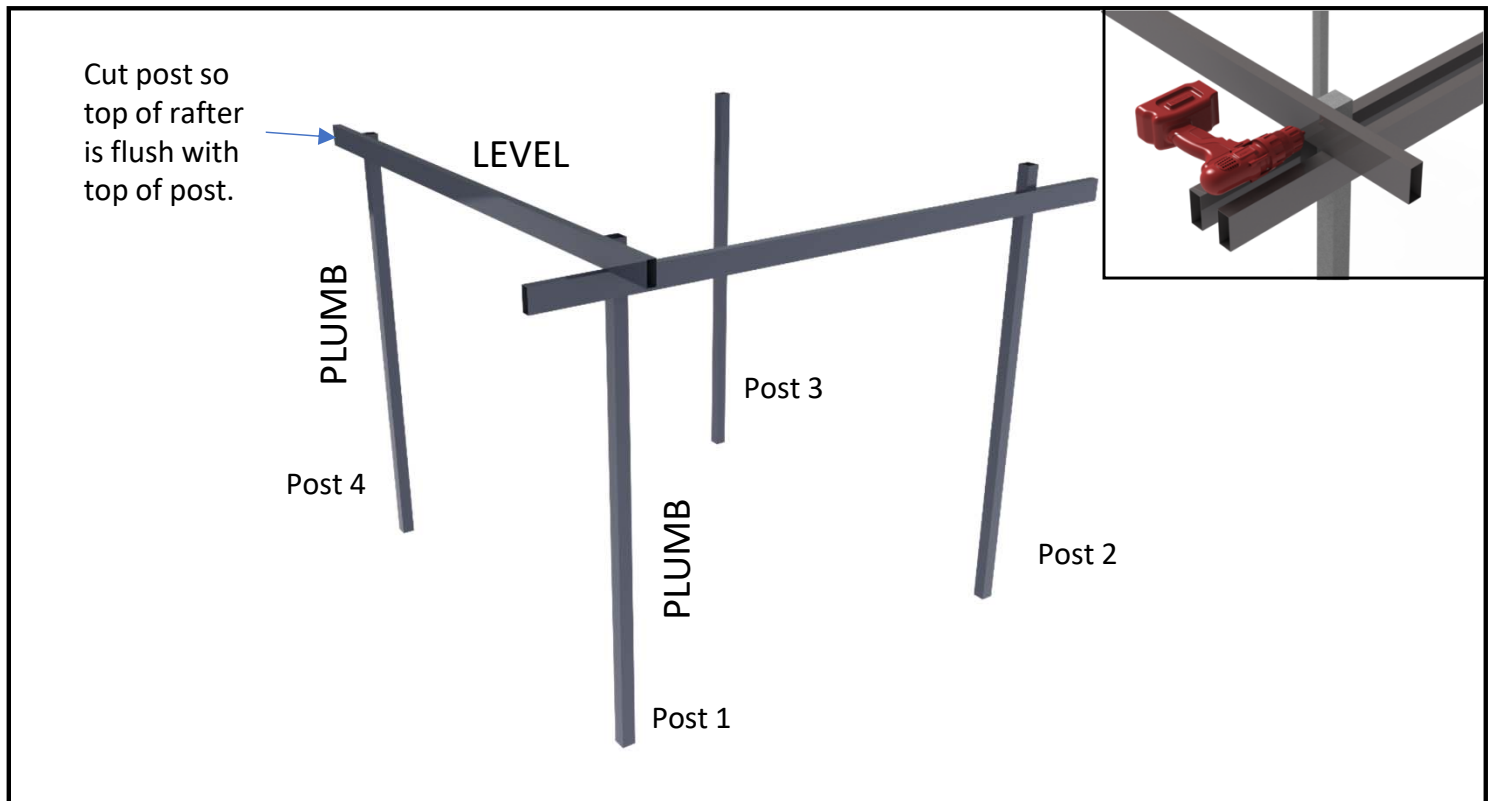

11. **CUT** the marked post at the line. Recheck level and fix the rafter to the post using #14 TEK screws through the pre drilled holes.
12. Repeat steps 10 & 11 for the second set of posts, using a second pre-drilled rafter (posts 2&3 in the example image).

Part 3: Installing the Posts & Beams

13. Push another beam to the underside of the two rafters... RE-CHECK beam to be LEVEL. FASTEN through the access holes into the posts using the #14 tek screws (**Image 20**).

14. Push remaining beams up to underside of rafters on the inside face of the posts...Hold the posts plumb level vertically, center the BEAM 5/8" access holes to the posts..

15. FASTEN through the access holes into the post using the #14 tek screws (**Image 21**).

Image 20

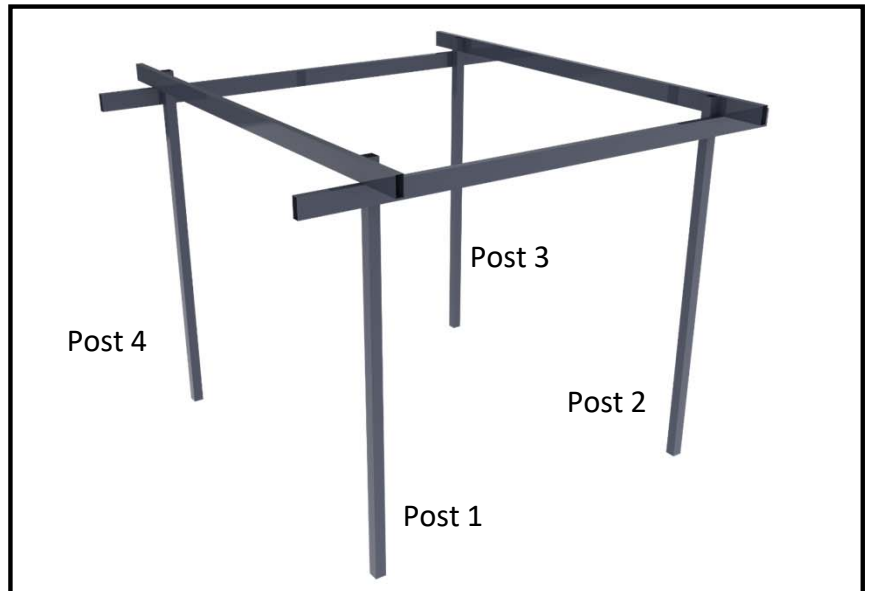
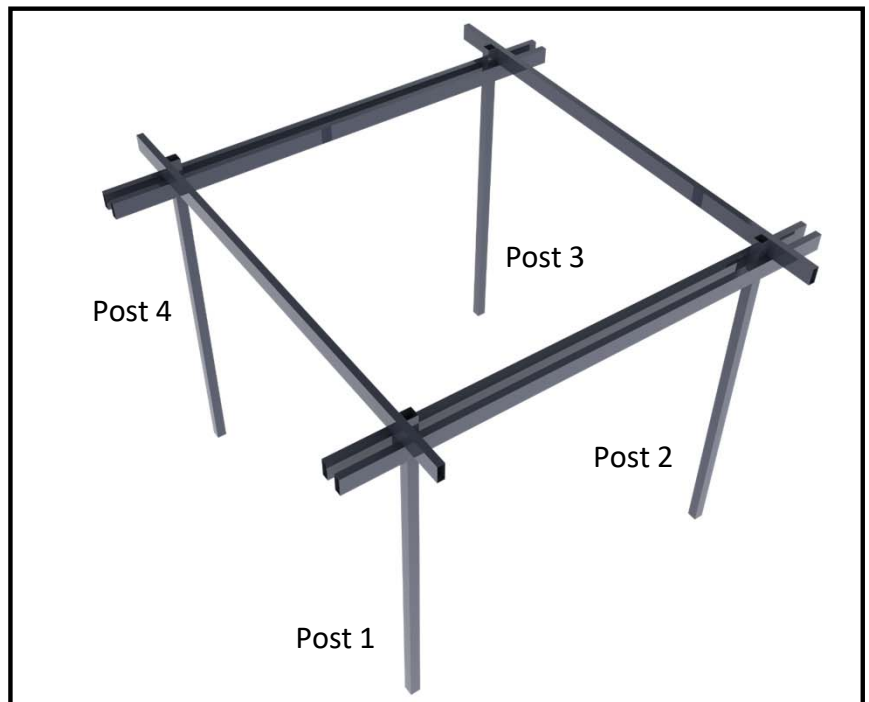

Image 21



Part 3: Setting the Posts and Beams

20ft Pergolas Only – Skip to Part 4 if not applicable

For 20ft wide pergolas: Install the 2 remaining posts and bases by lining up the centre of the 3” post with the central beam split point. Once lined up drill 5/8” access holes and fix to the posts. Then fix the bases to the ground using the method in part 3. Add the 3” posts and fix beams into post. **Image 22.**

Image 22



Part 4: Securing Posts

1. Drill a 3.5” hole through the post and base plate stubs.

Image 23

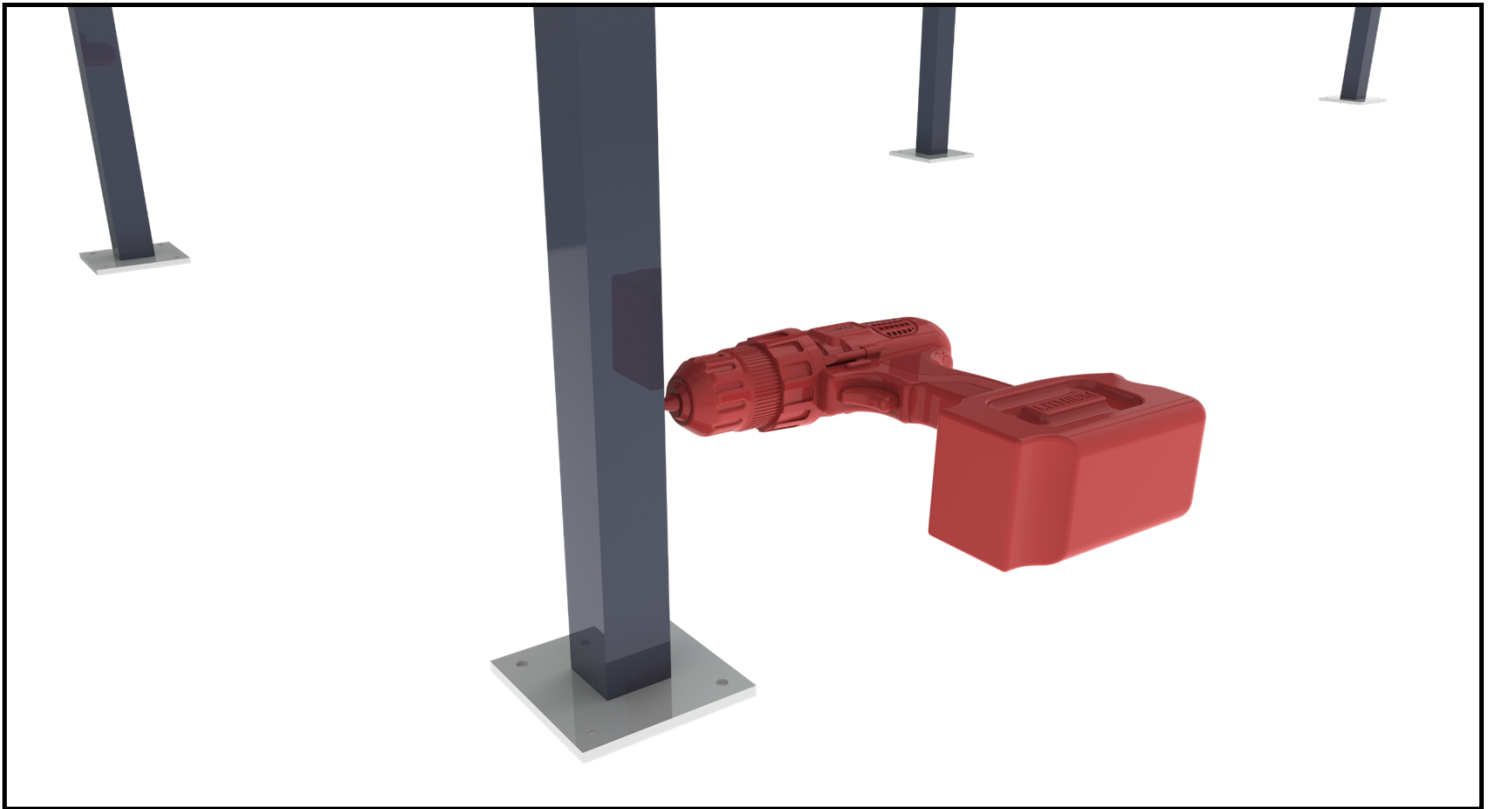

2. Insert a bolt, place a washer and nut on the end and tighten.
3. Repeat for all posts.

Part 5: Installing Rafters

1. Push the remaining **pre-drilled** rafters up against the inside face of the posts. **For 20ft pergolas – also place pre-drilled rafters either side of the central post.** You should now have rafters on either side of all posts. Lay out the remaining rafters with equal spacing and make sure they are parallel. Place angle brackets on one side of the rafters **(Image 24)**.

Image 24

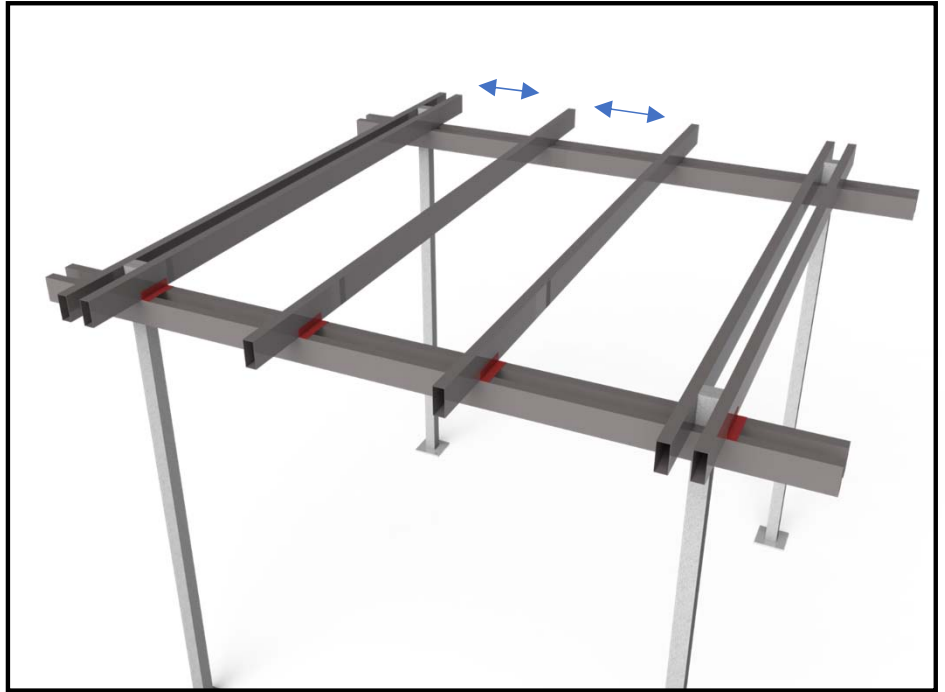

2. Make sure the brackets are perpendicular to the beams. Fasten the brackets to the beams using 2 #10x3/4 tek screws into each beam - 4 total. **(Image 25)**.

Image 25

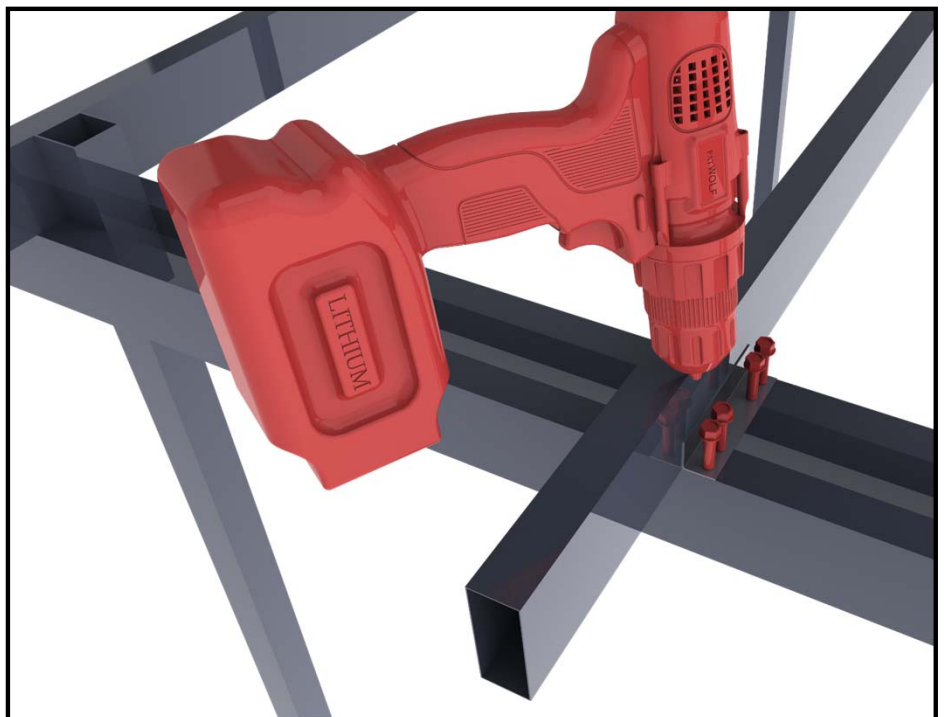

Part 5: Installing Rafters

3. Fasten angle brackets to the beams at the other end of the rafters using the same method. **Image 26.**
4. Make sure all the rafters have an equal overhang over the beams.

Image 26



Part 5: Installing Rafters

Image 27



Part 5: Installing Rafters

5. Make sure the RAFTER is STRAIGHT & UPRIGHT. FASTEN BOTH ENDS using Two (2) #10x3/4 tek screws through the Angle Bracket into the Rafter over each beam. **(Image 28).**

Image 28

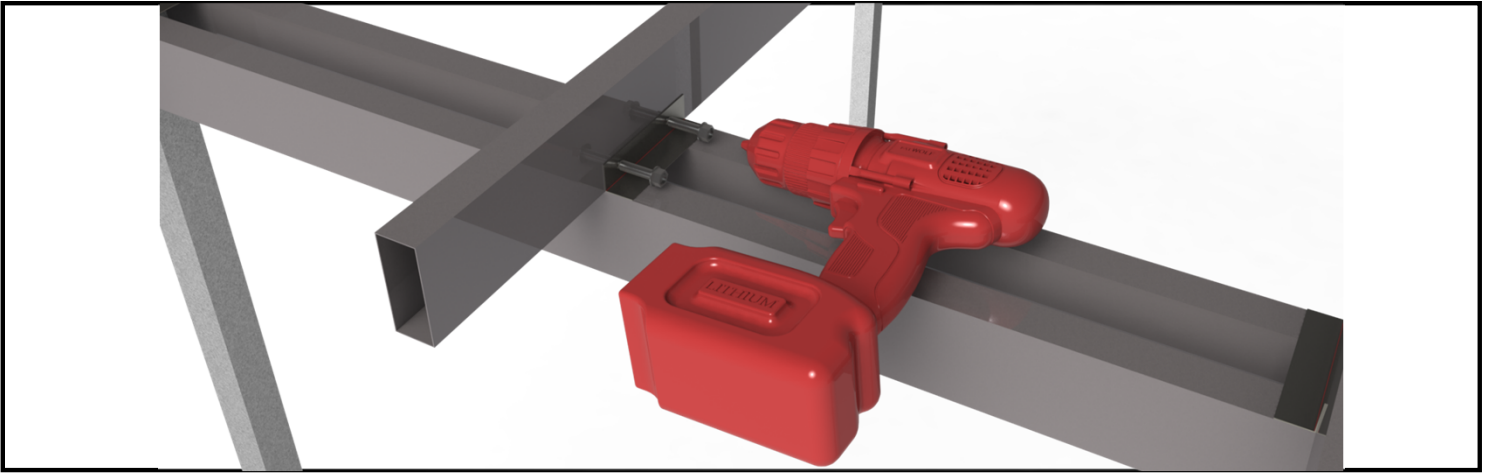

6. Fasten the pre-drilled rafters to the inside of the posts using 1 #14 TEK screw. **(Image 29).**

Image 29

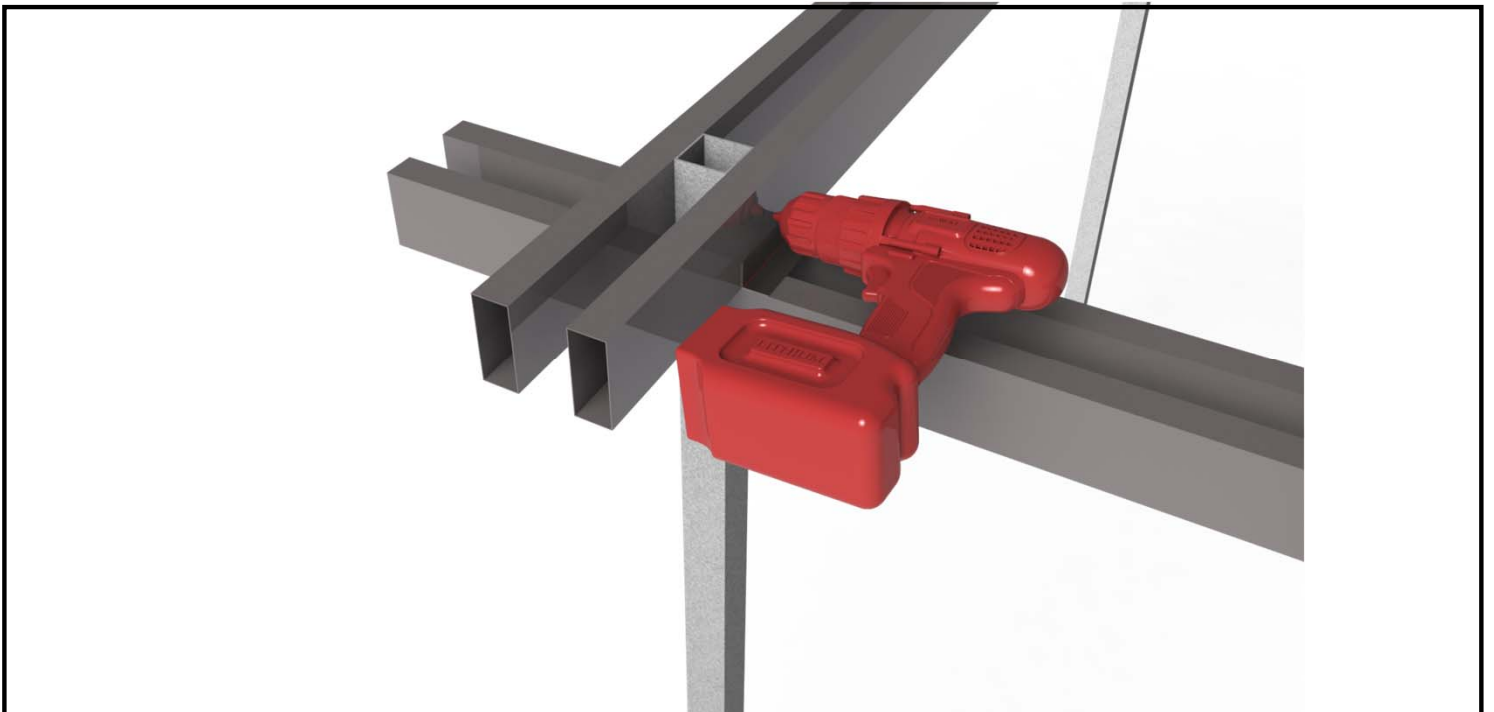

Part 5: Installing Rafters

7. Fasten the remaining **RAFTER ANGLE BRACKETS** to the **DOUBLE BEAMS** and to the other side of each **RAFTER**. Push the Rafter **ANGLE BRACKET** **TIGHTLY** against the **RAFTERS & FASTEN. (Image 30).**

Image 30



Part 6: Installing Final Endcaps

1. Install the beam end caps using the same method in part 2 (**Image 36**).

Image 31

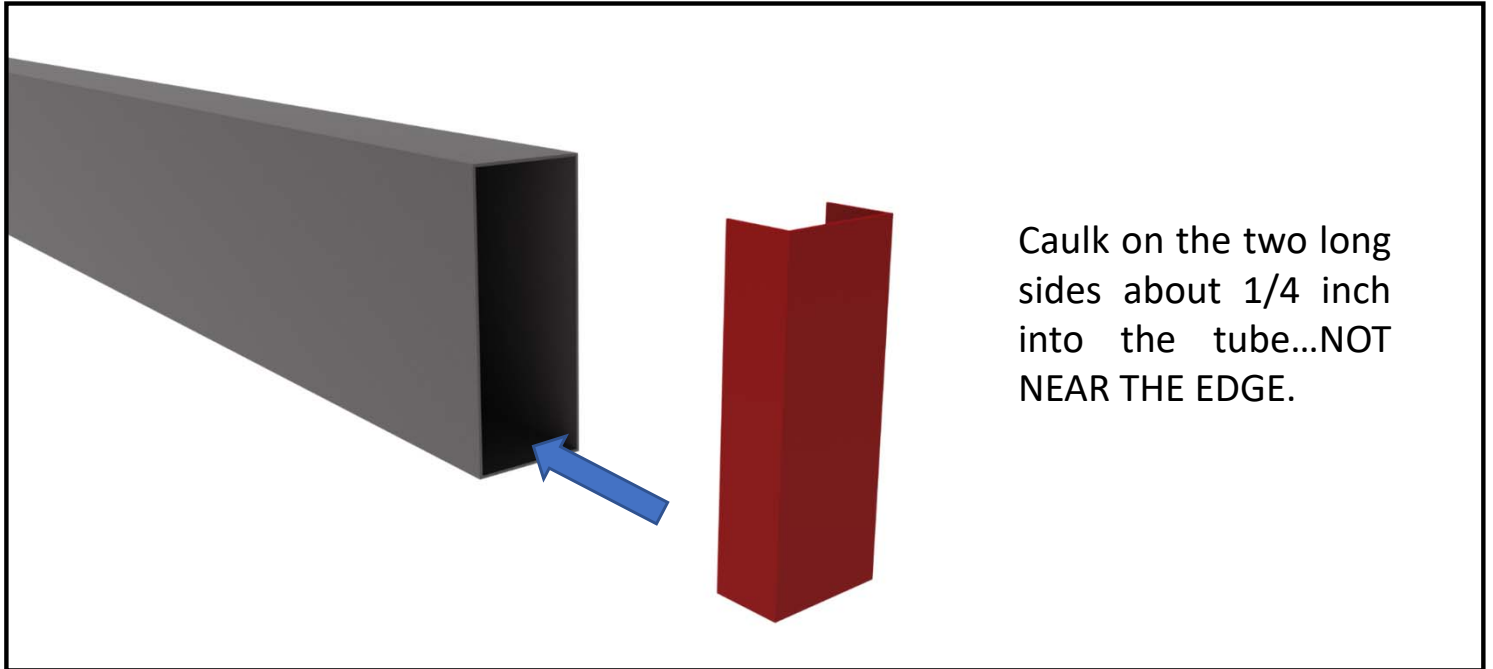

2. Install post endcaps using the same method (Image 37).

Image 32

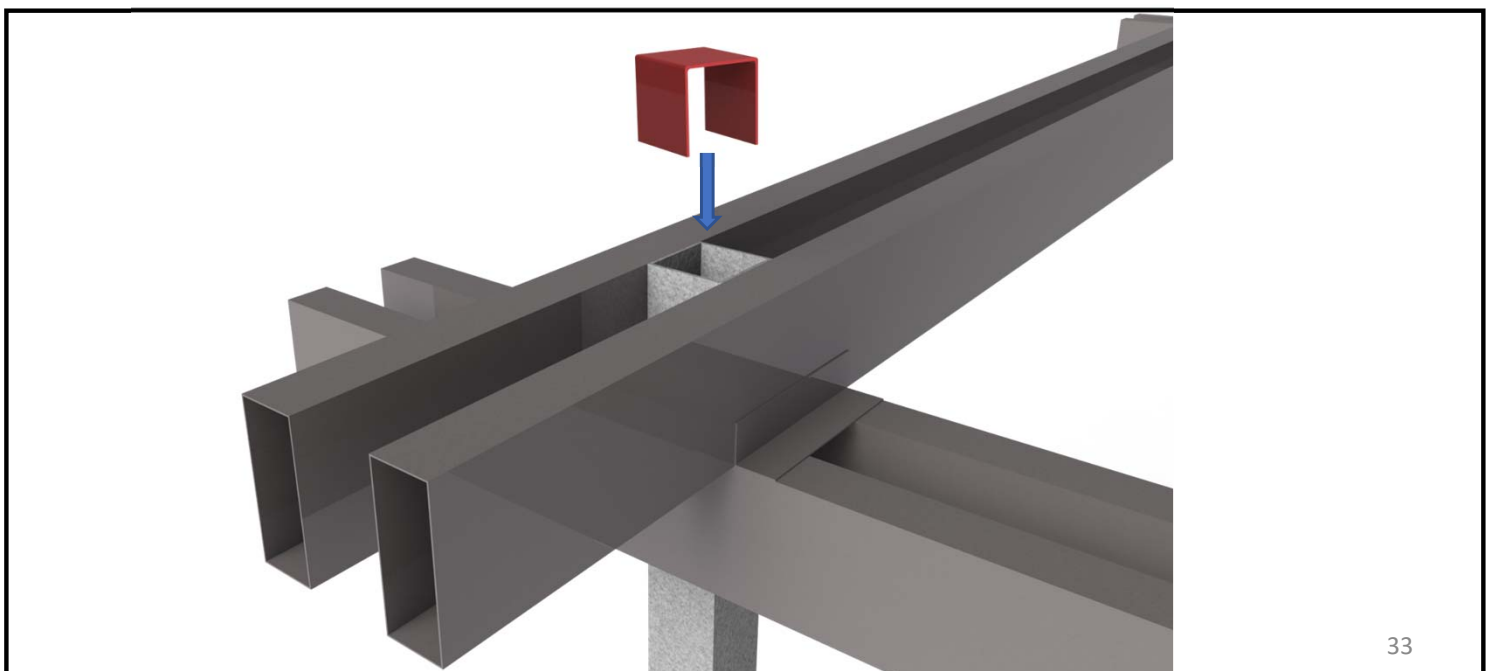

Part 7: Installing Shadepickets

12 ft pergolas: This pergola will have 12ft 1x3 Shade slats. At the FRONT & BACK of the RAFTERS, MEASURE & MARK 3" on the TOP SIDE of the FIRST, LAST and MIDDLE RAFTERS.

16 ft pergolas: Join two (2) 1x3 slats together on top of the rafters...fasten using one (1) #10x3/4" tek screw. This pergola will have 16ft 1x3 Shade slats. At the FRONT & BACK of the RAFTERS, MEASURE & MARK 3" on the TOP SIDE of the FIRST, LAST and MIDDLE RAFTERS.

20 ft pergolas: Join two (2) 1x3 slats together on top of the rafters...fasten using one (1) #10x3/4" tek screw. This pergola will have 20ft 1x3 Shade slats. At the FRONT & BACK of the RAFTERS, MEASURE & MARK 4-1/2" on the TOP SIDE of the FIRST, LAST and MIDDLE RAFTERS.

1. Take one 1x3 SHADE SLAT and set it BEHIND the FRONT MARK and place another slat IN FRONT of the BACK mark, as shown. **(Image 32).**

Image 33

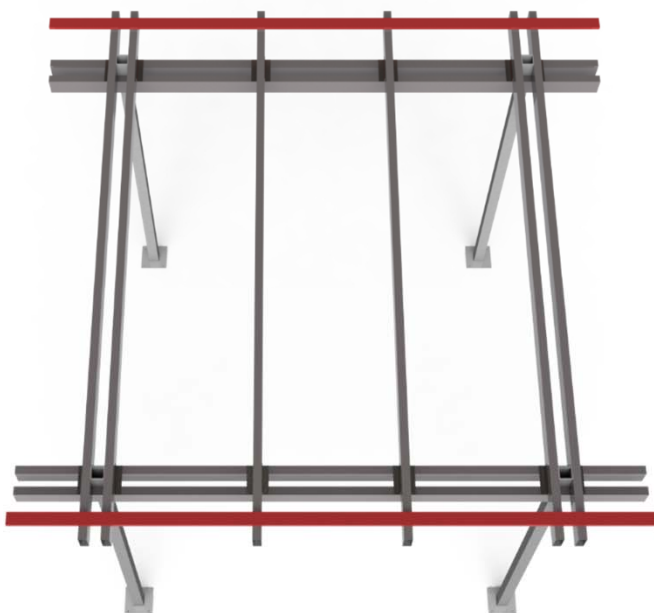

Part 7: Installing Shadepickets

2. Fasten using one (1) #10x2" Tek through the 1x3's into every Rafter.
3. Put the remaining 1x3 slats on top of the rafters pushing them against the first 1x3 slat in front. Make sure the ends are all flush with one another. **(Image 34).**

Image 34



4. The spacing between the shade slats is the width of 2 slats (6 inches). Therefore leave 2 and fasten the next shade slat to every rafter using 1 #10 TEK screw. **(Image 35).**

Part 7: Installing Shadepickets

Image 35



6. Remove the loose slats and repeat.
7. For the final slats, measure 6 inches from the previous slat. Position the slat and fix through **(Image 36)**.

Image 36

